

Unisys

Migrating to Open Systems

HP3000



Our Vision

- Today Unisys with our ES7000 servers account for more than 90% of the >8 CPU Windows systems installed worldwide
- We achieve this by recognising the business issues faced by large-scale Windows users
- No other vendor has our hard-won experience of Enterprise level Windows environments

Microsoft

&

Unisys

An Enterprise Alliance



Joint Engineering

Core Windows 2000/.NET

Dynamic Partitioning

Disaster Recovery

DB2 / SQL Server

64bit SQL / .NET

S Tech Centers

Field Programs

SA



Scalable Windows Platform

Unisys ES7000

- 32 Intel Xeon MP Processors
- 64 GB Memory
- 96 PCI slots
- High Performance Crossbar
- Partitioning
 - Hardware and Software
- Key Mainframe Attributes
 - Scalable
 - Reliable
 - Manageable



ES7000 Architecture

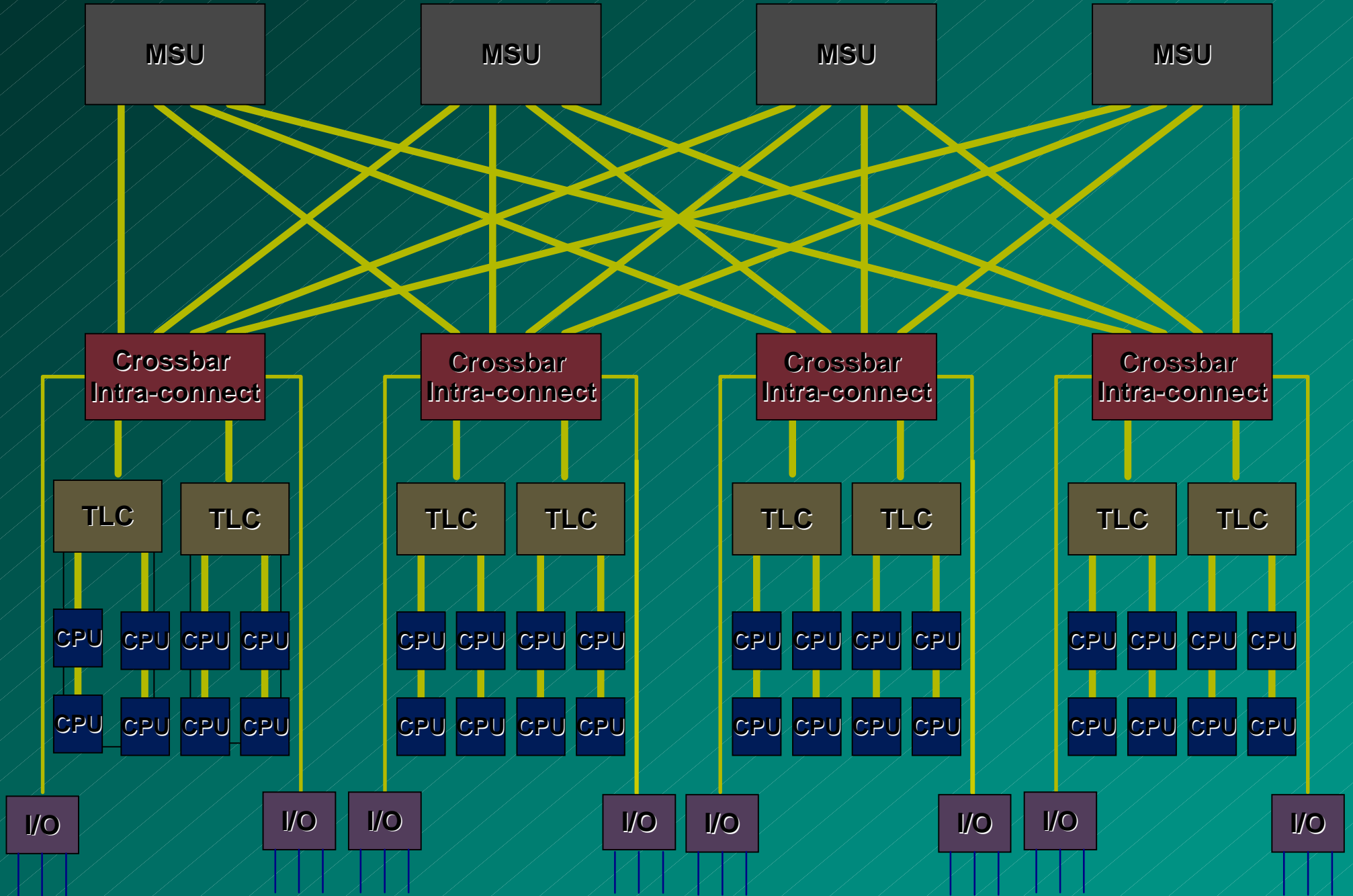

Scalable Modular Components

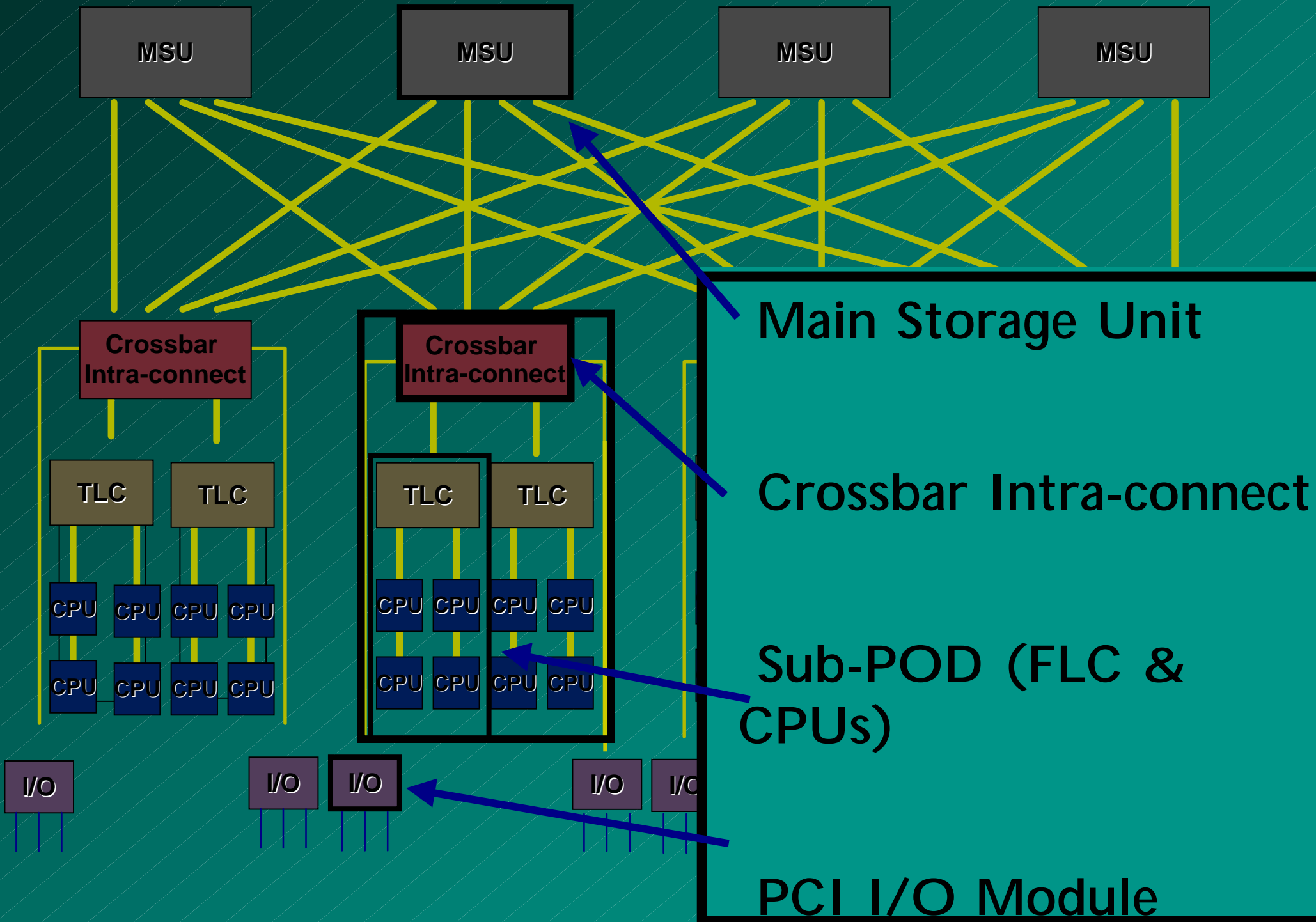

ES7000 Scaling Up

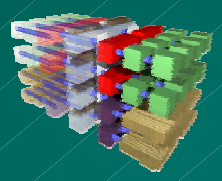
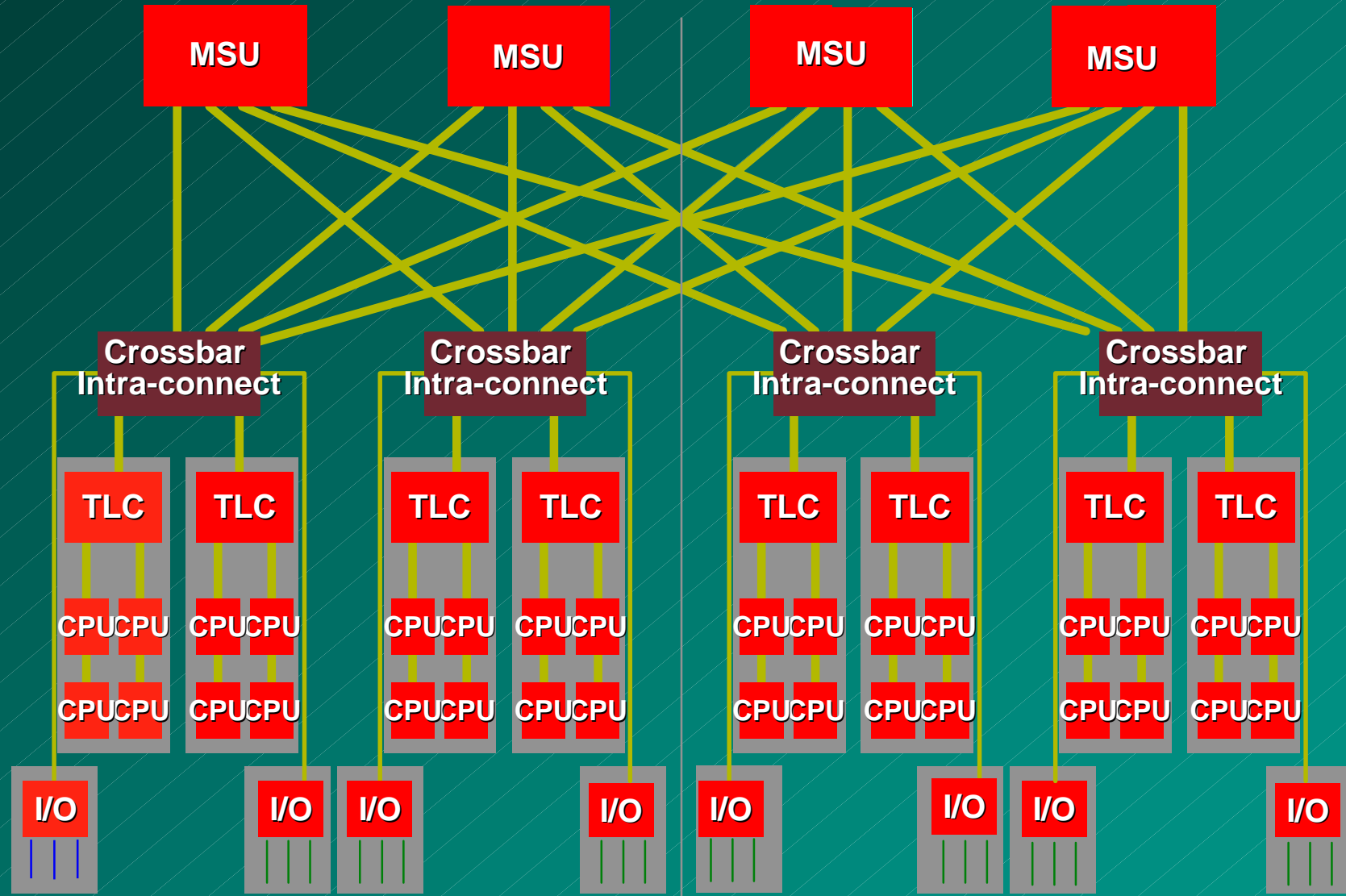
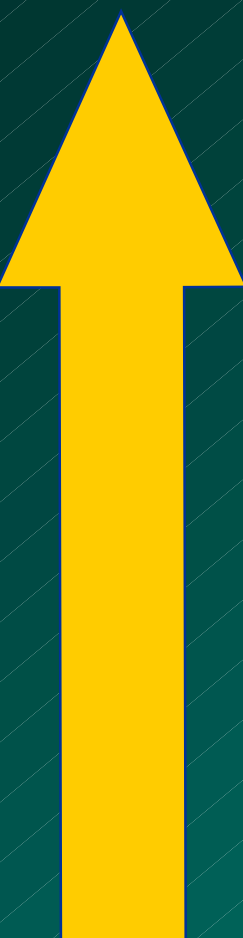

ES7000 Partitioning

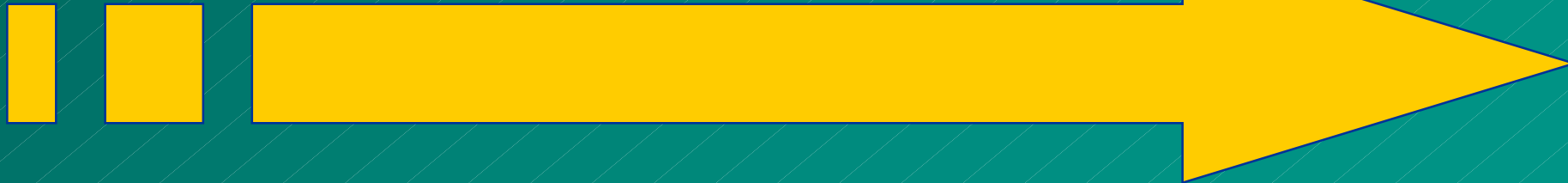
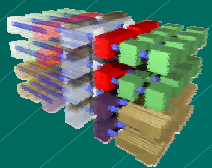
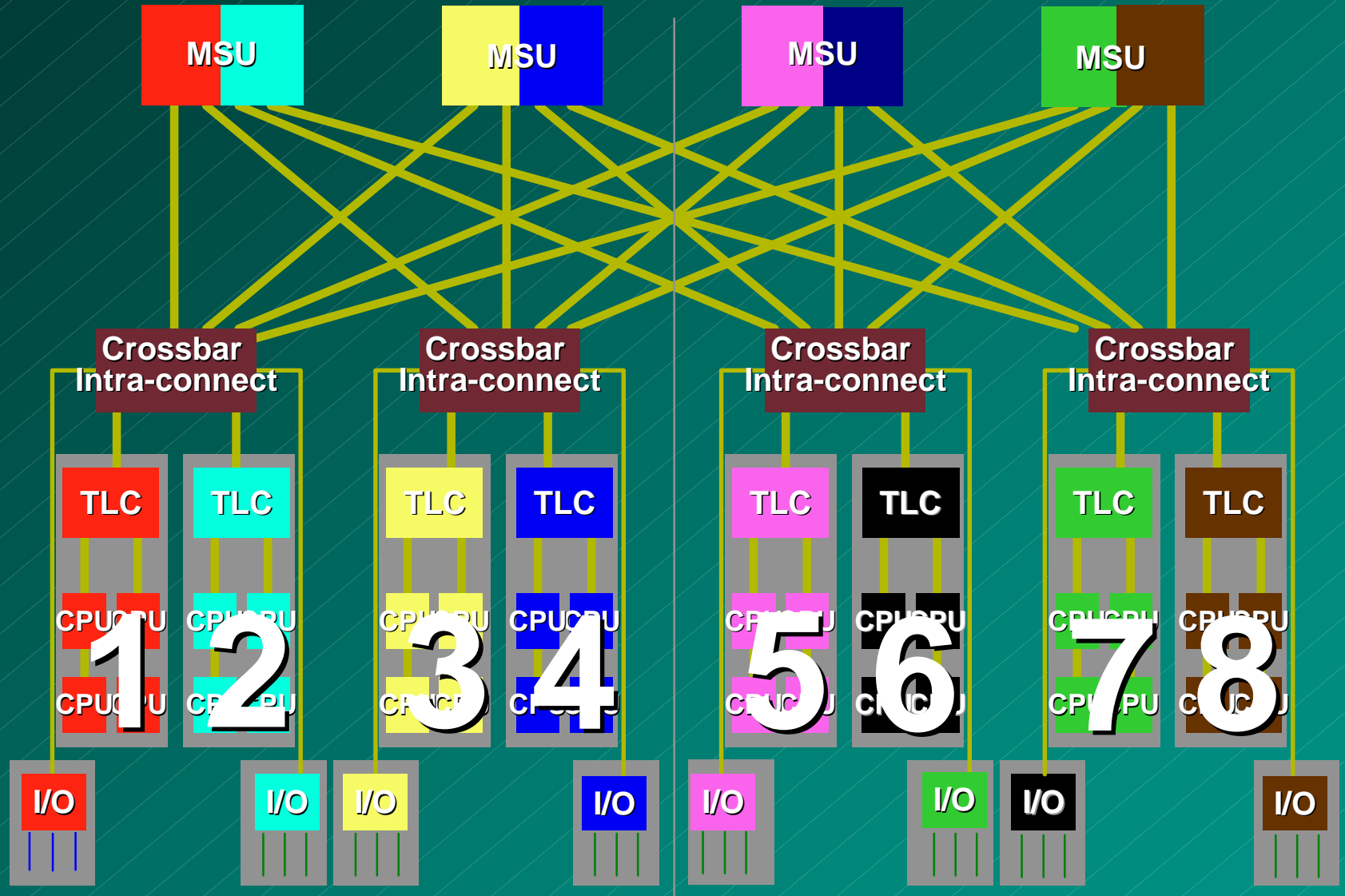

ES7000 – Common Usage Model

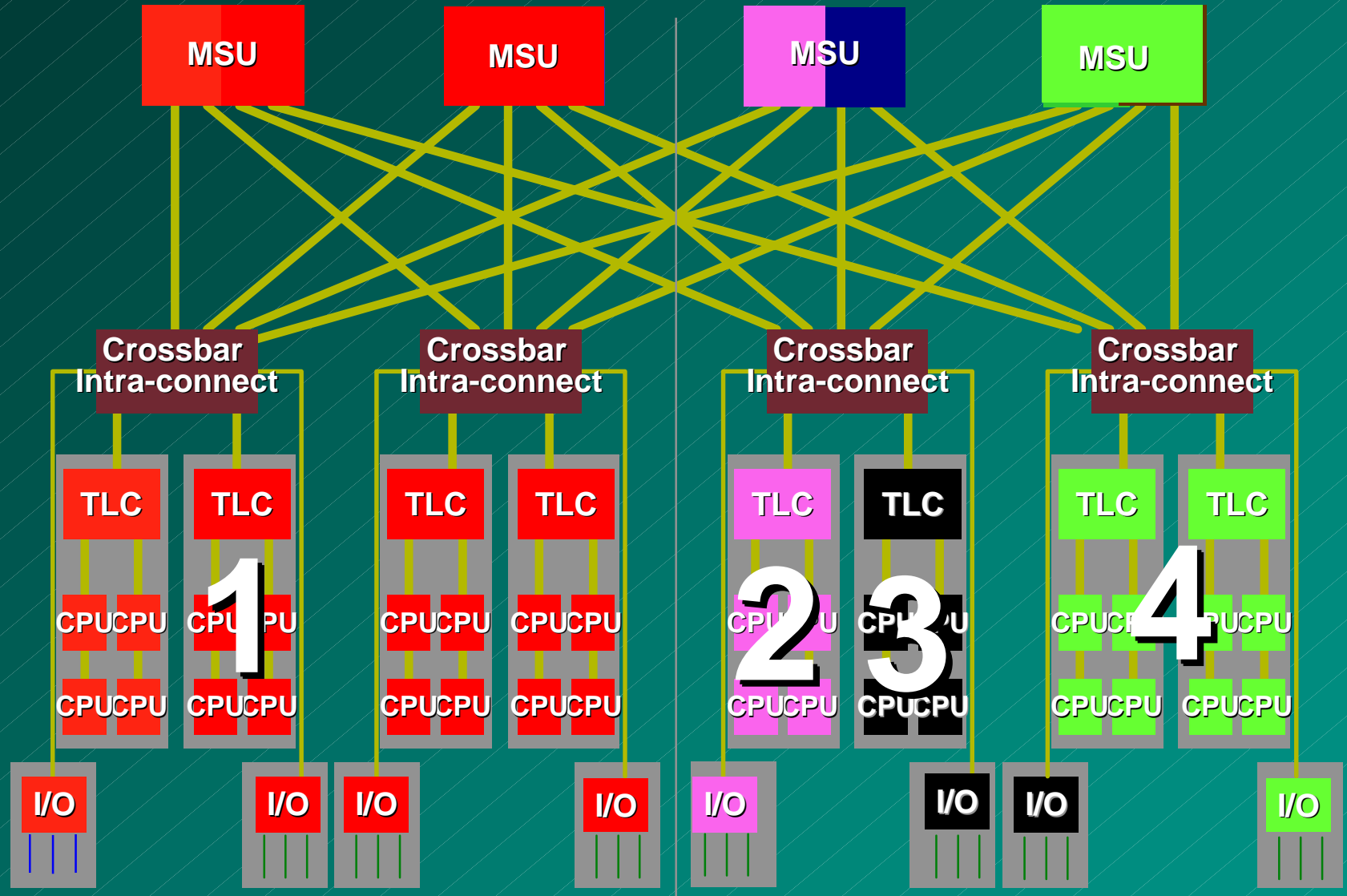

Unisys, Microsoft, and Unicon Value Proposition

- Scalability of largest Unix Systems
- Availability of Mainframe Systems
- Manageability of Personal Computer
- Investment Protection in Technology
- Surrounded by World Class support and services

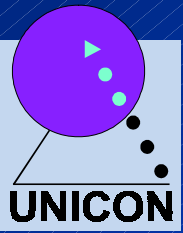

Today's Agenda

- Company Overview
- Migration Methodology
- Products
- Services
- Review

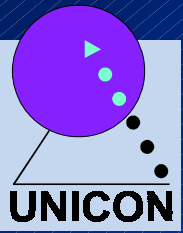

Today's Agenda

- **Company Overview**

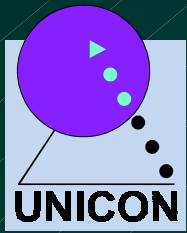

Unicon Locations



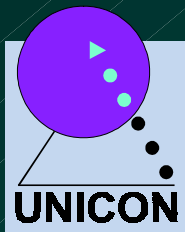

Mission Statement

To provide effective conversion solutions for migrating legacy software from proprietary environments to open-architecture systems...

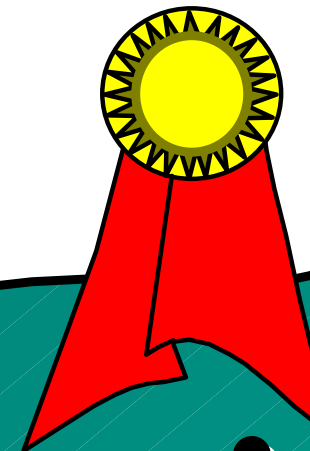

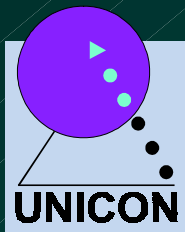

Legacy Systems

- **WANG VS**
- **IBM CICS**
- **IBM AS400**
- **DEC VAX**
- **HP 3000**

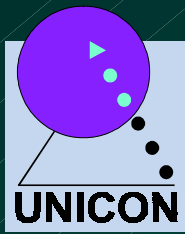

Open System Network

Windows Server

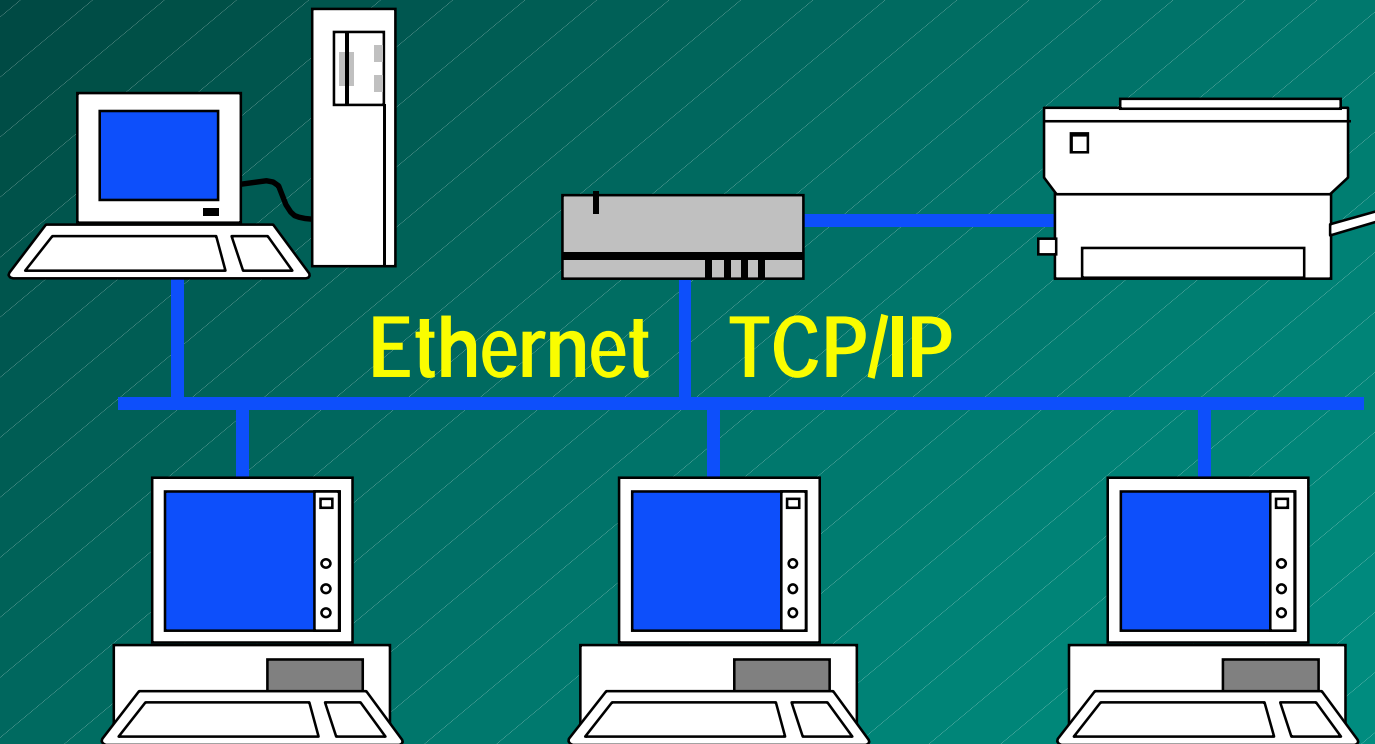

Microsoft Windows Clients



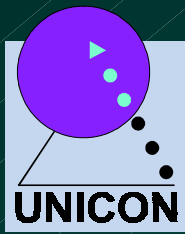

Open System COBOLS

- **RM / Liant**
- **Micro-Focus**
- **ACUCOBOL**
- **Fujitsu**

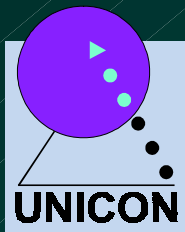

Selected Clients

Alaska National Insurance
American Reinsurance Co.
Amtech
Applied Data Solutions
Auto-Graphics, Inc.
ASTM International
Bisys Investment Services
Bureau of Engraving
Marsh (CT Bowring)
Carpenters Trusts
Cincinnati Public Schools
Continental General Insurance
Crazy Shirts, Inc.
Detroit Diesel Allison
Frazer Paints
General Communications Inc.
Georgia Dept of Education

Guardian Royal Exchange
Irly Distributors
Island Farms Dairies Co-Op
Manning & Napier
Metlife Capital Corp.
Mutual Marine Office, Inc.
Office-Max
Pacific Machinery & Tool Steel
Process Technology
Research & Productivity Council
San Diego City Schools
Sarah Lee (Host Apparel)
Seagram Americas
Tate & Lyle
Triumph International
Union Insurance Co
Venus Knitting Mills

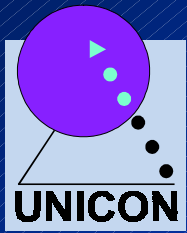

Today's Agenda



Company Overview



Migration Methodology

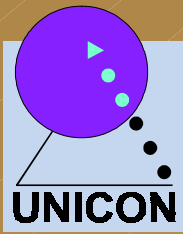

Migration Method

- **Emulation**
- **Conversion**

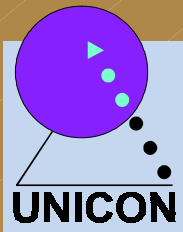

Migration Strategy

HP3000

MIGRATION TO OPEN SYSTEMS

- No emulation
- No middleware
- No intrinsics



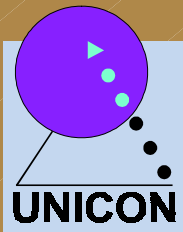

Migration Strategy

HP3000 SYSTEM

- HP COBOL
- VPLUS
- KSAM
- IMAGE / ALLBASE
- JCL



CONVERTED SYSTEM

- OPEN SYSTEMS COBOL
- SCREEN SECTION (WINFORM)
- VISION / C-ISAM
- MS-SQL / ORACLE
- SCRIPTS OR .BAT



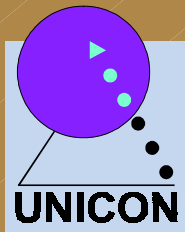

It isn't only COBOL

- **Assembler / Fortran / Basic**
- **PowerHouse**
- **Transact**
- **Speedware**
- **Suprtool**
- **Quiz, Quick**



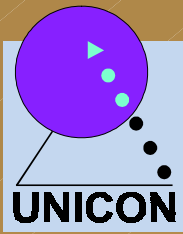

It isn't only COBOL

- FCOPY, Copyrite
- Intrinsic
- JCL
- Editor
- Print Queue
- Data Conversion



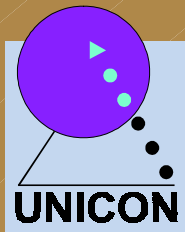

Open System Options

- Open Systems COBOL
- UNIX
- WINDOWS
- Microsoft SQL/Server
- ORACLE
- DB2
- Utilities (Powerhouse, etc)



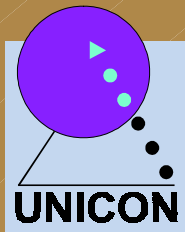

Project Lifecycle

- **System Preparation**
- **Automated Conversion**
- **Initial Testing**
- **Delivery**
- **Training**
- **System Testing**
- **Live Running**



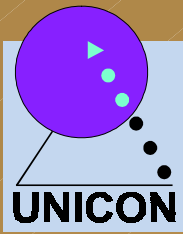

Migrated System

- **Sound Foundation**
- **Maintainable**
- **Upgrade-able**
- **Enhance-able**
- **Adaptable**
- **Web capable**
- **Long term viability**



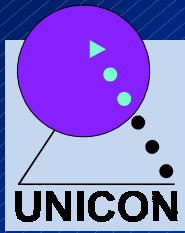

Today's Agenda



Company Overview



Migration Methodology



Products

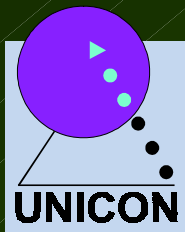

Products Overview

- **Editor**
- **Data Entry / Control**
- **Display**
- **Menu**
- **Create**
- **Sort**
- **Print Queue**



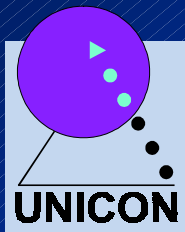

Today's Agenda

- Company Overview**
- Migration Strategy**
- Products**
- Services**

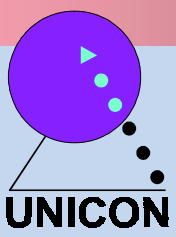

Services Overview

- Conversion Services
- Training
- Project Management
- Technical Consulting
- Live-run Implementation
- Software Modification
- Hardware Consulting
- Software Support

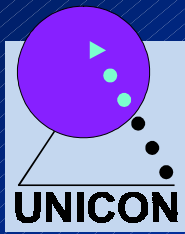

Today's Agenda

- Company Overview**
- Migration Strategy**
- Products**
- Services**
- Review**

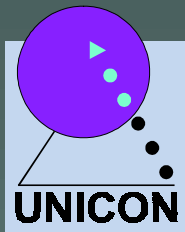

Review

- **Stable Company**
- **Conversion Experience**
- **Proven Conversion Tools**
- **Proven Methodology**
- **Solid Track Record**
- **Solid References**
- **Support Program**



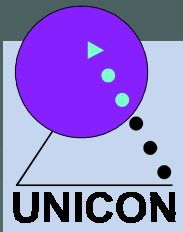

Review

- **Total Conversion Solution**
- **No emulation or middleware**
- **VPlus screens**
- **COBOL source**
- **IMAGE tables**
- **Jobs**
- **Database Conversion**
- **Commitment**



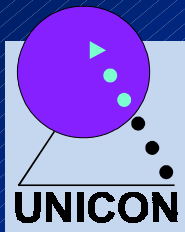

Today's Agenda

- Company Overview**
- Migration Strategy**
- Products**
- Services**
- Review**



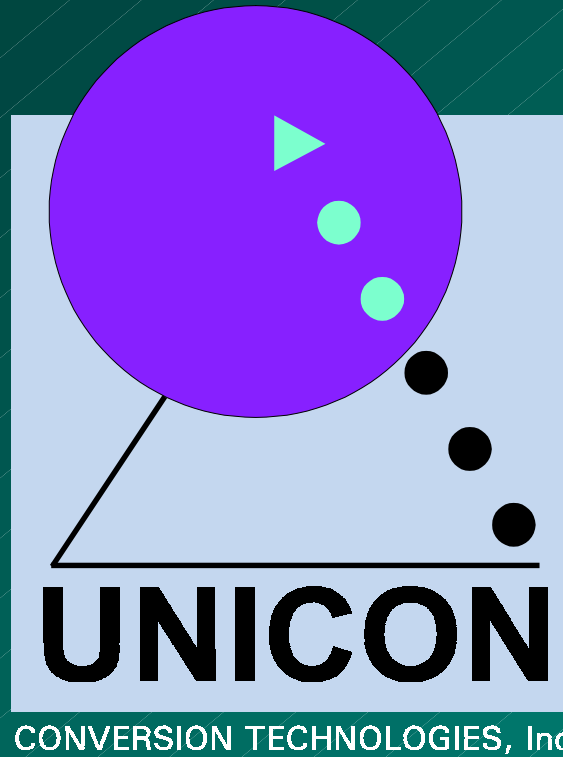

Any Questions ?