

# Migrating 3GL Applications

**Scott Pierson**

President

Lund Performance Solutions

[scott.pierson@lund.com](mailto:scott.pierson@lund.com)

**HP Platinum Partner**

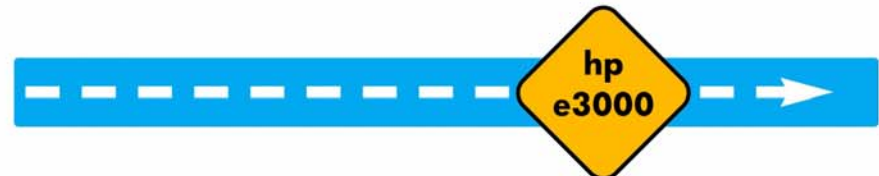

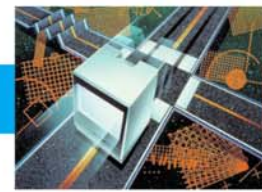

# Agenda

- Overview – Breaking Down The Problem
- Cobol
- Other 3GLs
- Automated Migration Solutions
  - Selecting a solution
- Final Advice

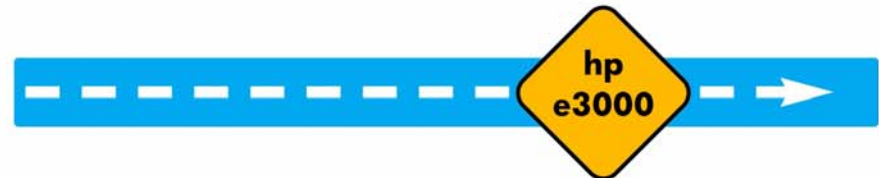

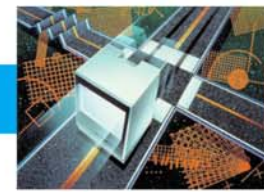

# Overview

## Breaking Down The Problem

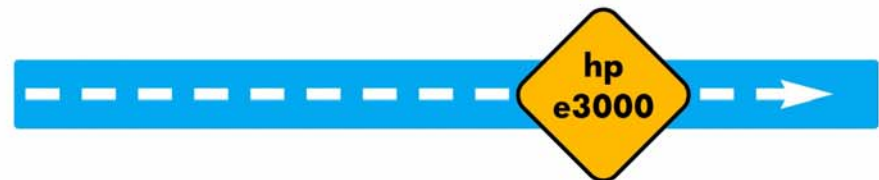

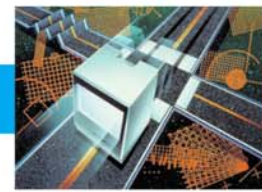

# 3GL Languages

- Cobol
- Fortran
- Pascal
- RPG
- C
- SPL
- Business Basic

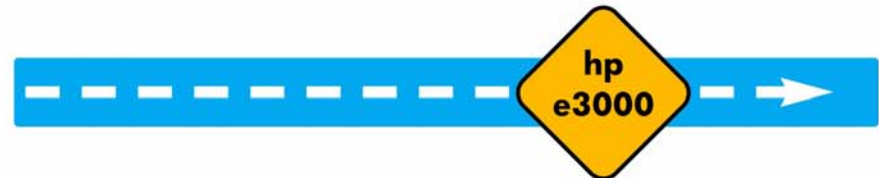

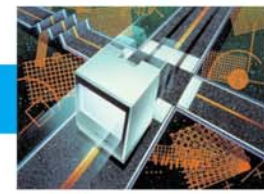

# Major Components

- 4 major components of an application to deal with in a migration
  - 3GL Code Migration
  - Terminal Interface (VPlus)
  - Database / File Interface (Image, KSAM, Flat, etc)
  - OS Interaction (Intrinsics, commands, spooler, job queue, system variables, JCL, hardware device interaction, UDCs, etc.)

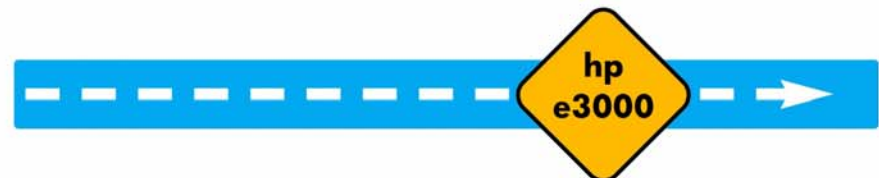

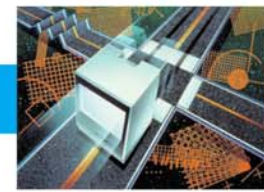

# Other Issues

- Emulate or migrate
  - Emulate Image vs. migrate to SQL
  - Emulate JCL vs migrate to new OS scripts
  - Emulate VPlus vs. migrate to new GUI
- Recompile or translate?
  - recompile
    - picking the right compiler
    - picking the right migration tool
  - translate
    - stay in the language you're in on the 3000 or translate to another language?
      - What to do about VPlus, Image, MPE intrinsics
    - modern languages (java; Legacyj)
    - move gradually

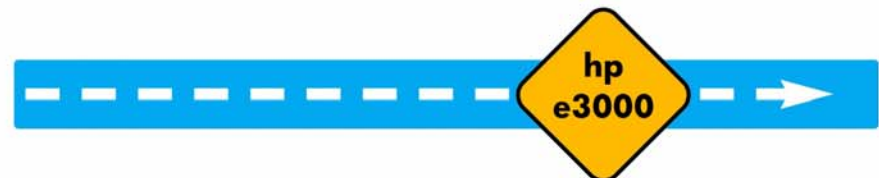

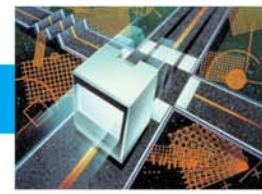

# Other Issues

- Subsystem Decisions

- If your programmers have written highly modular code, the migration will be easier
  - All the statements that must be modified will be in a single module
  - Not typical
- The more typical case:
  - Most programs laced with calls to VPlus, TurboImage and other proprietary MPE intrinsics
  - Migrating this kind of code is much more difficult
  - May need to consider emulation as an alternative

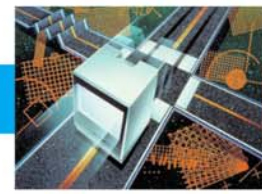

# Cobol Migrations

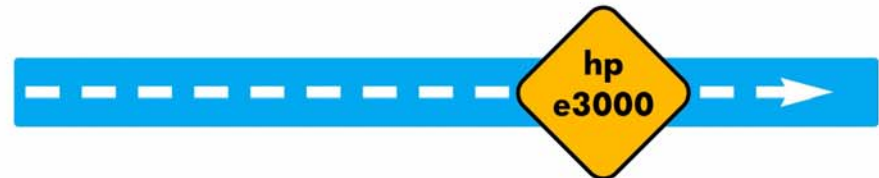



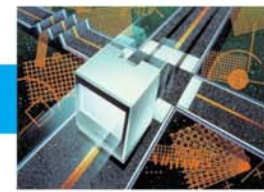

# 3GL Compilers (Cobol)

- Microfocus Cobol
  - Largest market share
  - Most costly
  - Native and portability options
- AcuCobol
  - Cheaper
  - Very popular with HP e3000 prospects
  - Portability and GUI interfaces
- Fujitsu Cobol
  - Not well known
  - Very cheap
  - Native solution only

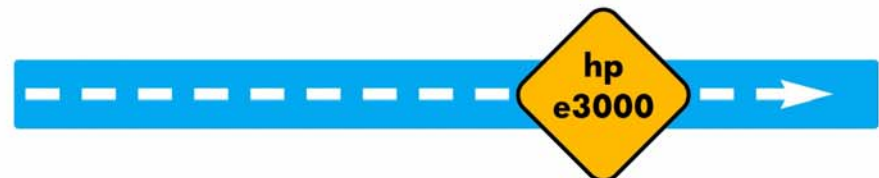

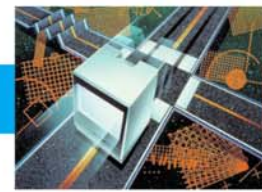

# Things to Consider

- Cobol Syntax
  - Reserved Words
  - Copy libs
  - \$INCLUDE
  - Macro expansion
- Reserved Words
  - For example: using “window” as a data item name works with hp cobol
    - AcuCobol uses “window” as a reserved word
    - With compile options you can turn off this reserved word, allowing you to leave the iem name



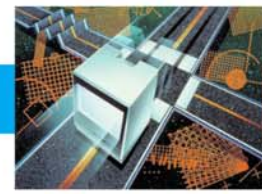

# Things to Consider

- Externals
  - Passing of parm and info in run command\
  - Entry points
  - CIERROR
  - Job/session environment (e.g. Temp files)
- File system
  - File naming (FILE.GROUP.ACCT)
  - MPE file types
  - Record structures
  - Sharing file IDs (FDs as Intrinsic parameters)
  - Sort files
  - KSAM files
  - FILE equations.
  - Temporary files

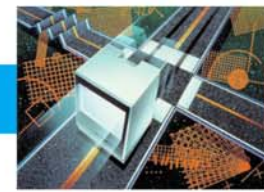

# User Interface Issues

- VPlus
  - Emulation vs. Migration
  - Migrating the Screen
  - Migrating the Processing Specs
  - Dealing with STDLIST
  - Long term maintenance
- Character mode
  - Emulation vs. Migration
- Moving to a new GUI?
  - Web, Client / Server, VB, Java, etc.

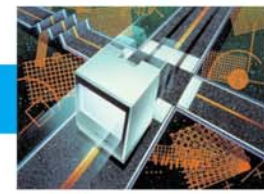

# VPlus Overview

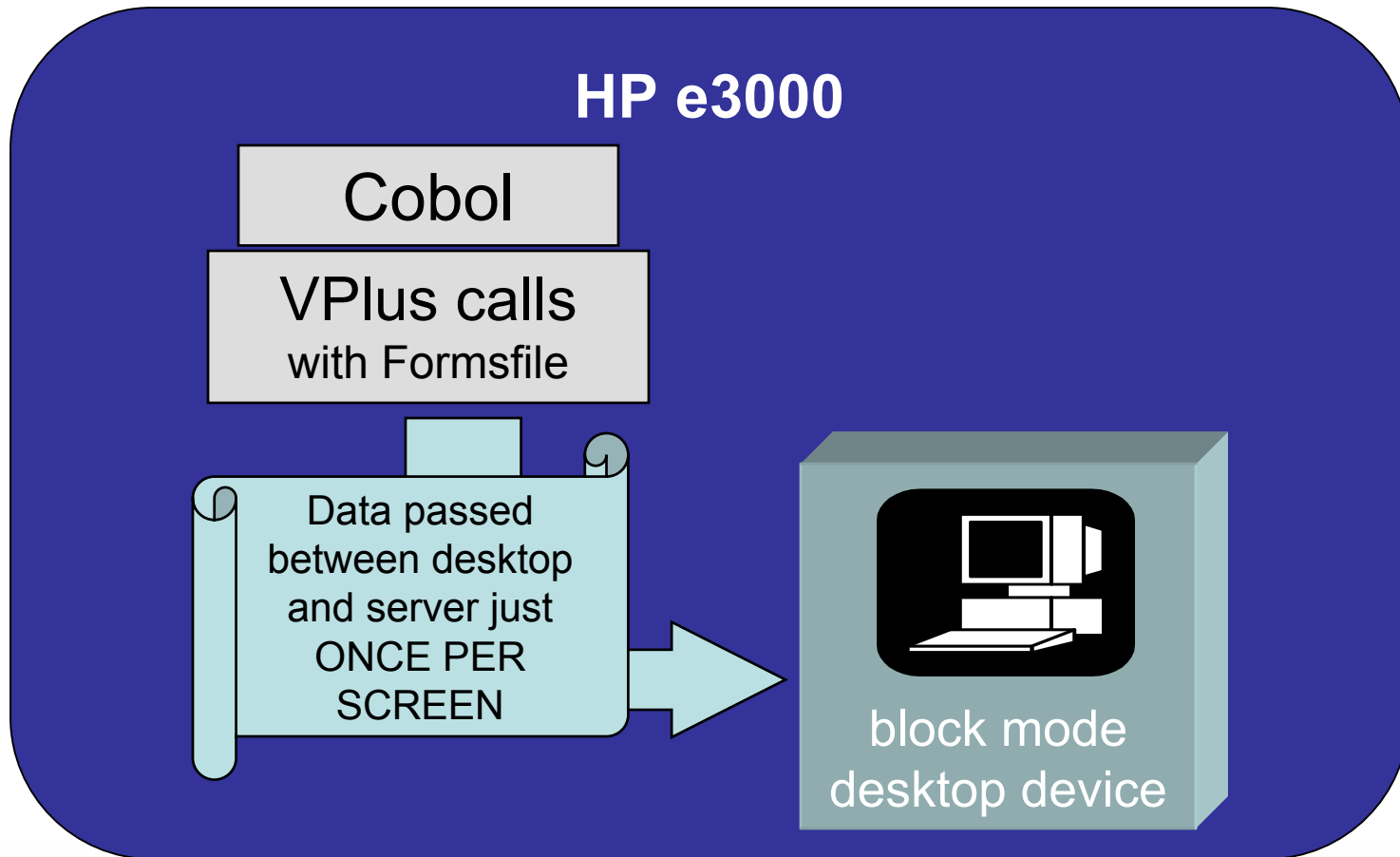

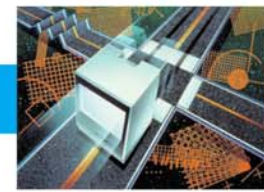

# Character Mode Applications Overview

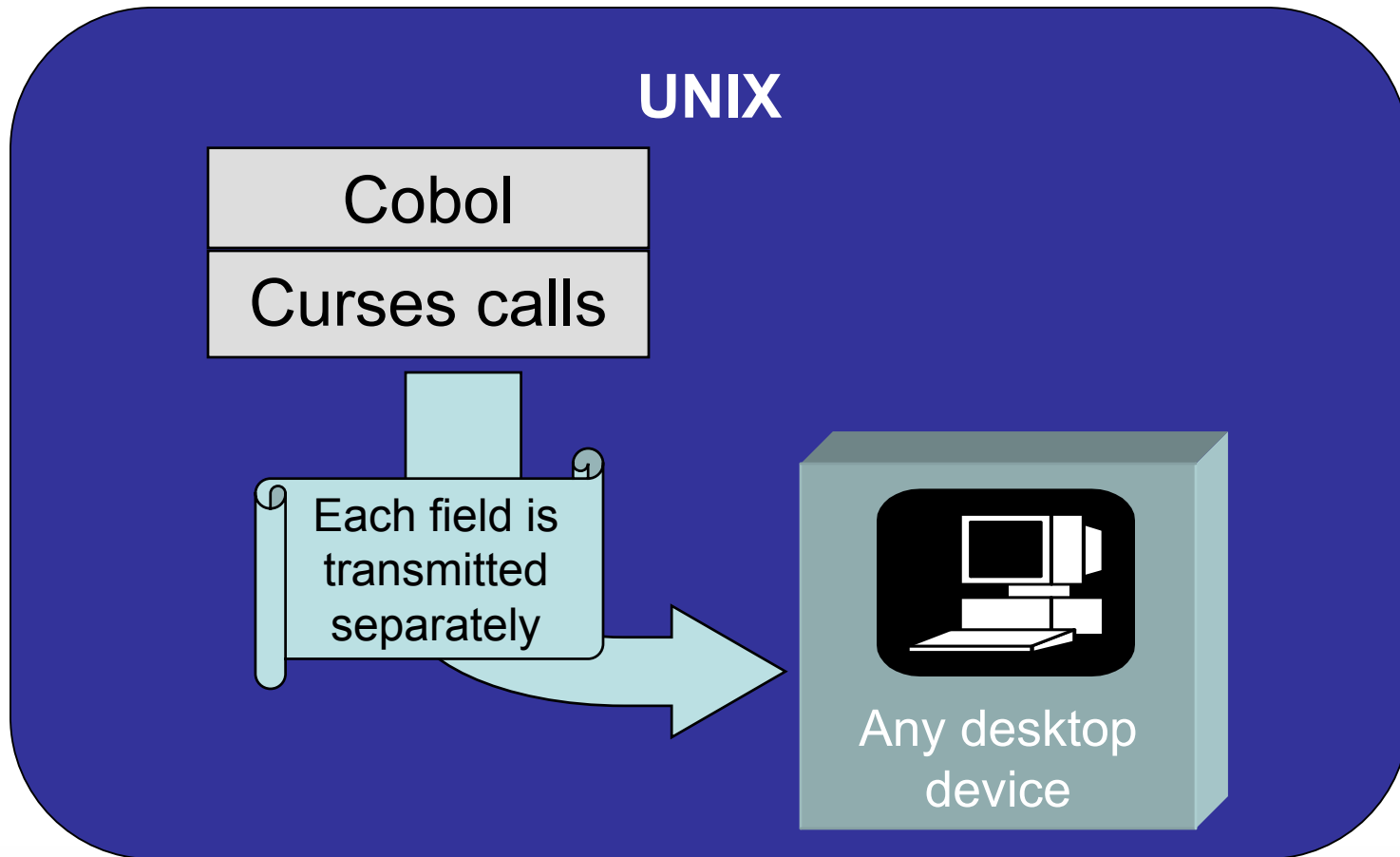

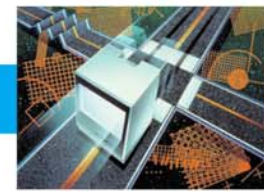

# Option 1: VPlus Emulation

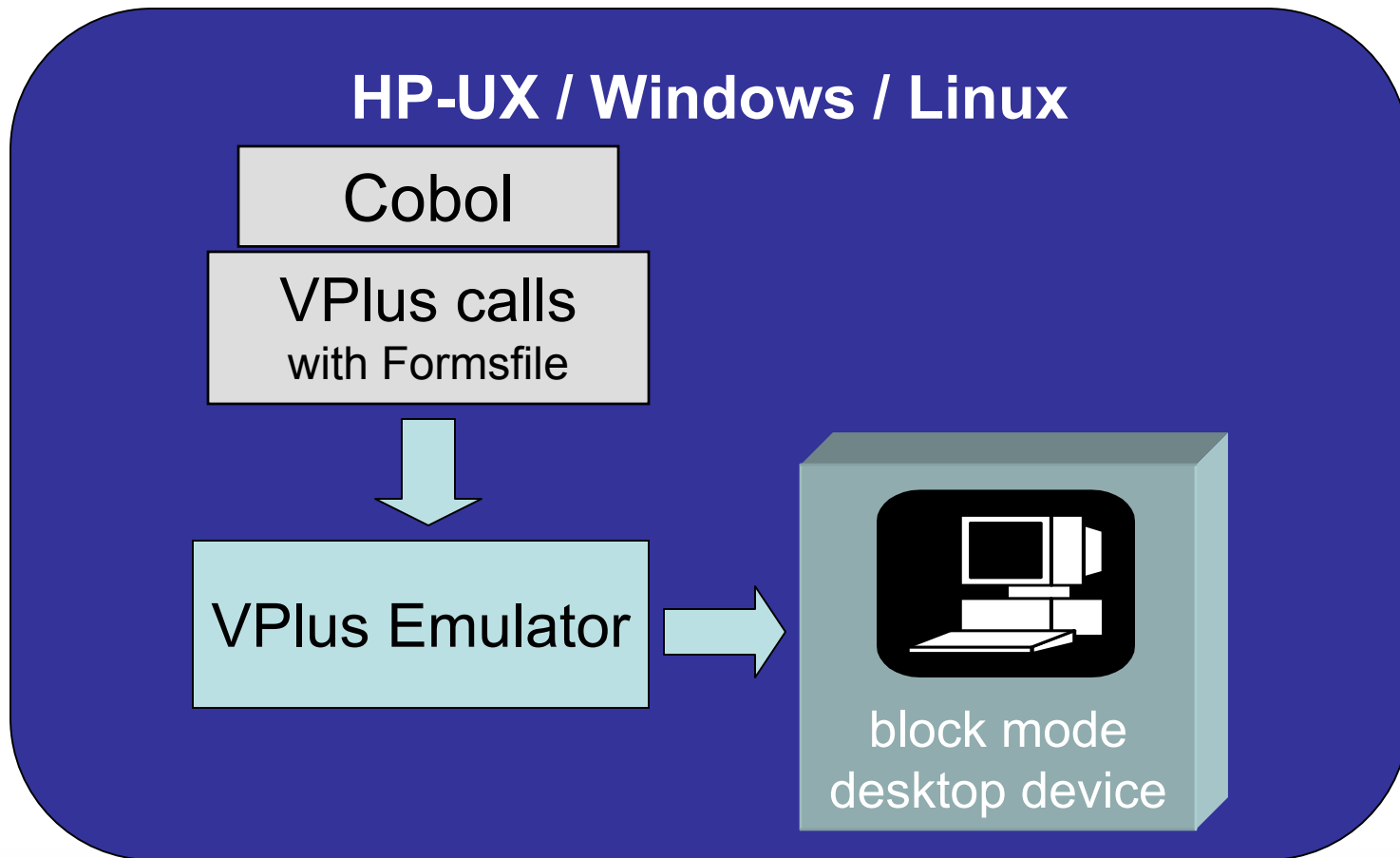

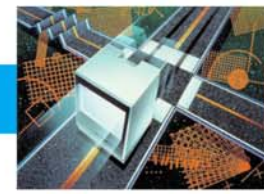

# Option 2: VPlus Interception / Translation

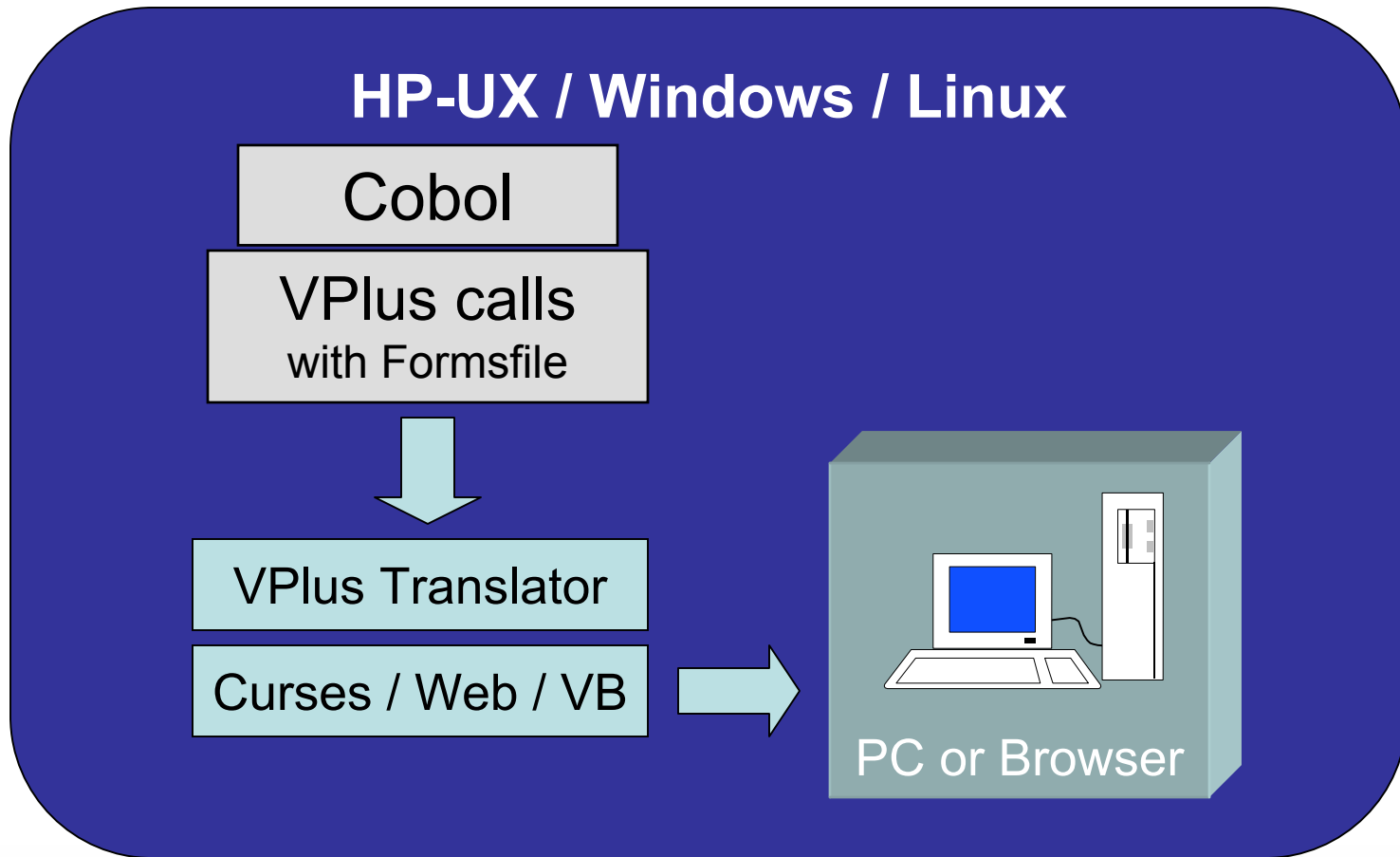



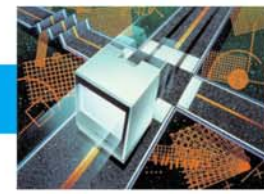

# Option 3: VPlus Replacement

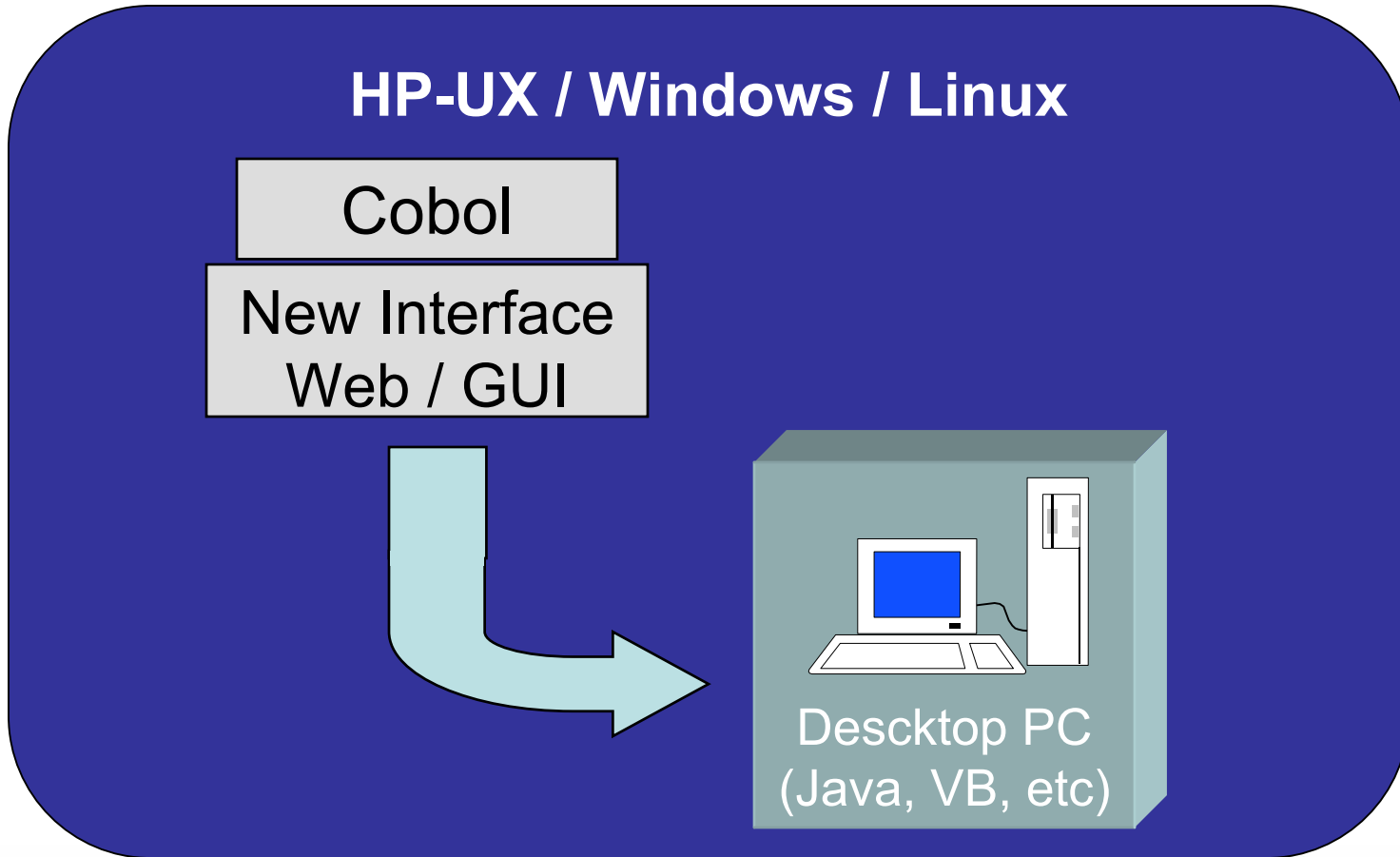

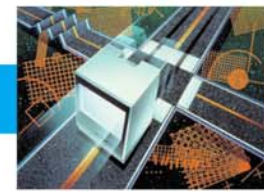

# User Interface Options / Alternatives

- Character-based solution / emulation (like Wingspan)
- GUI VPlus emulation (EdWin and ExegeClient)
- Cobol GUI (like AcuCobol GUI)
- Java (like PerCobol LegacyJ)
- Visual Basic GUI

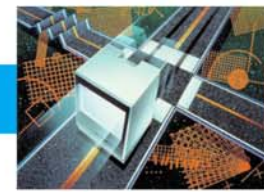

# Database / File Interface

- Replacing Image, KSAM, and specialized flat files with alternatives on other platforms creates new challenges
  - Data Structure Changes
  - Data Type Changes
  - Variable Name Changes
  - Database / File Access Changes
  - Data Migration

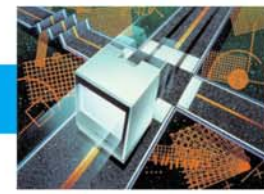

# How it works today

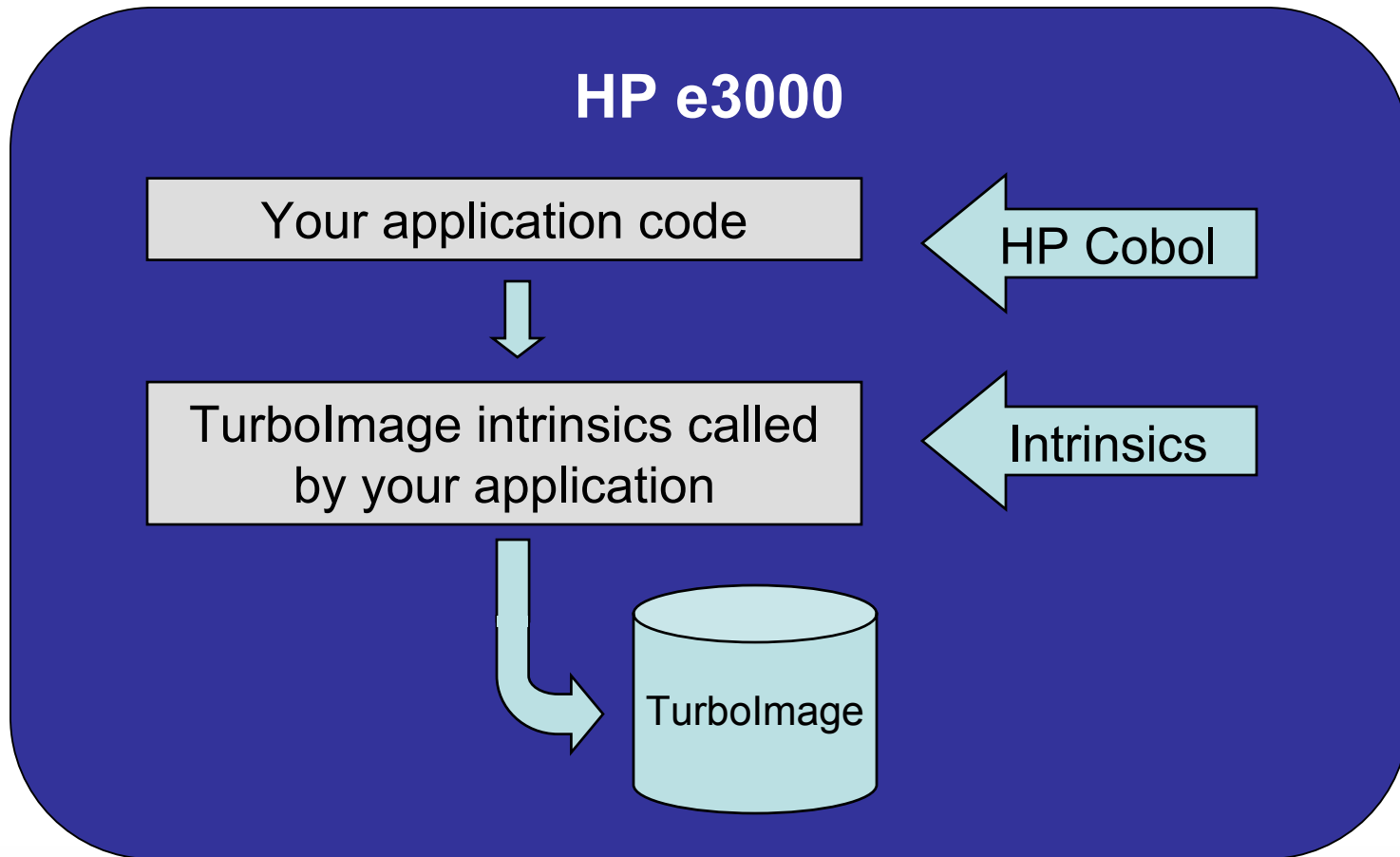

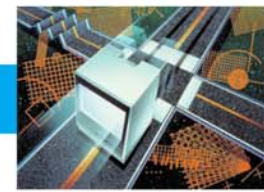

# Image Look-alike Option

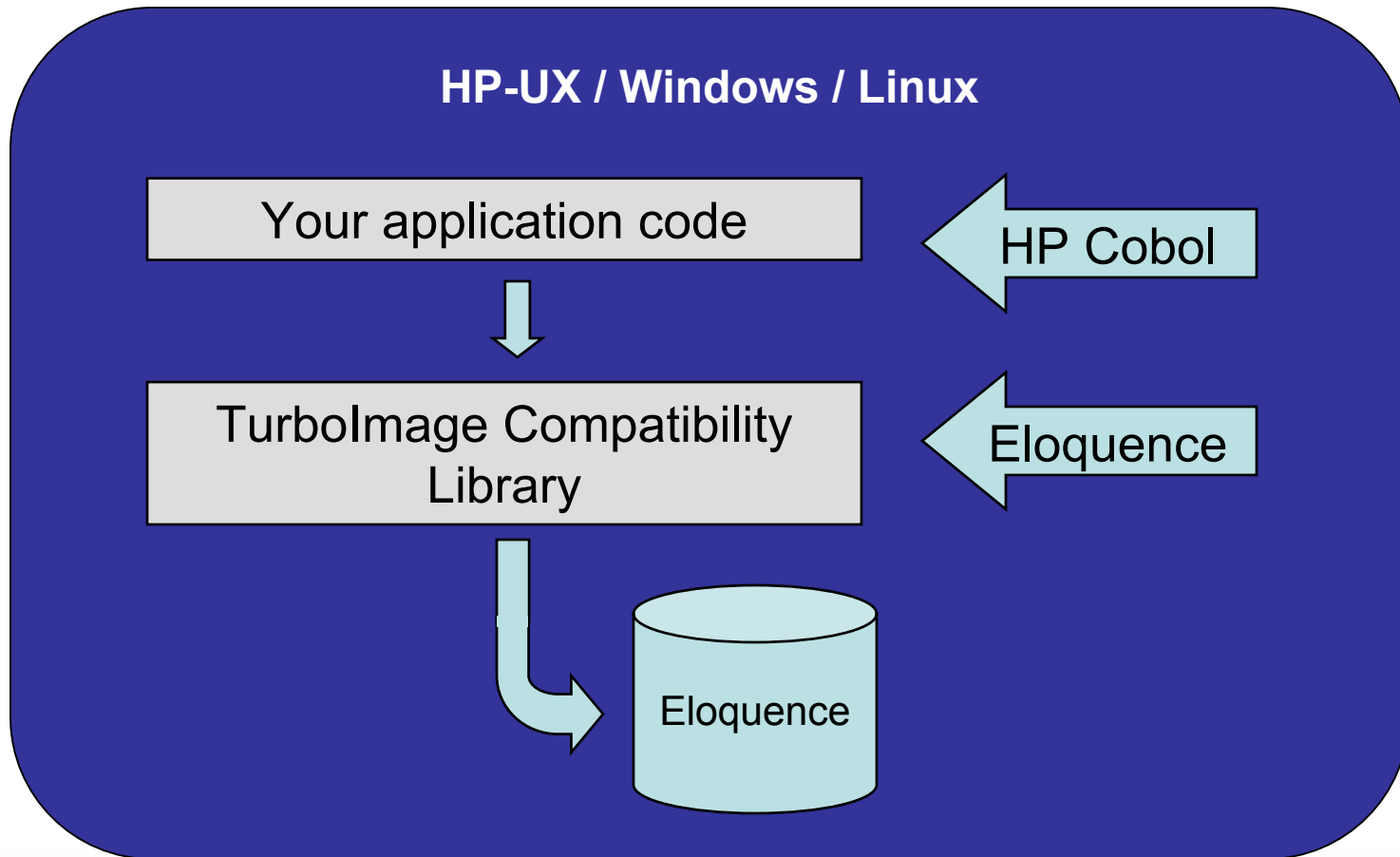

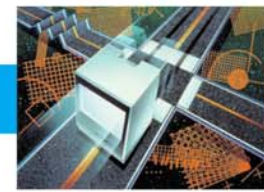

# Image Wrapper Option

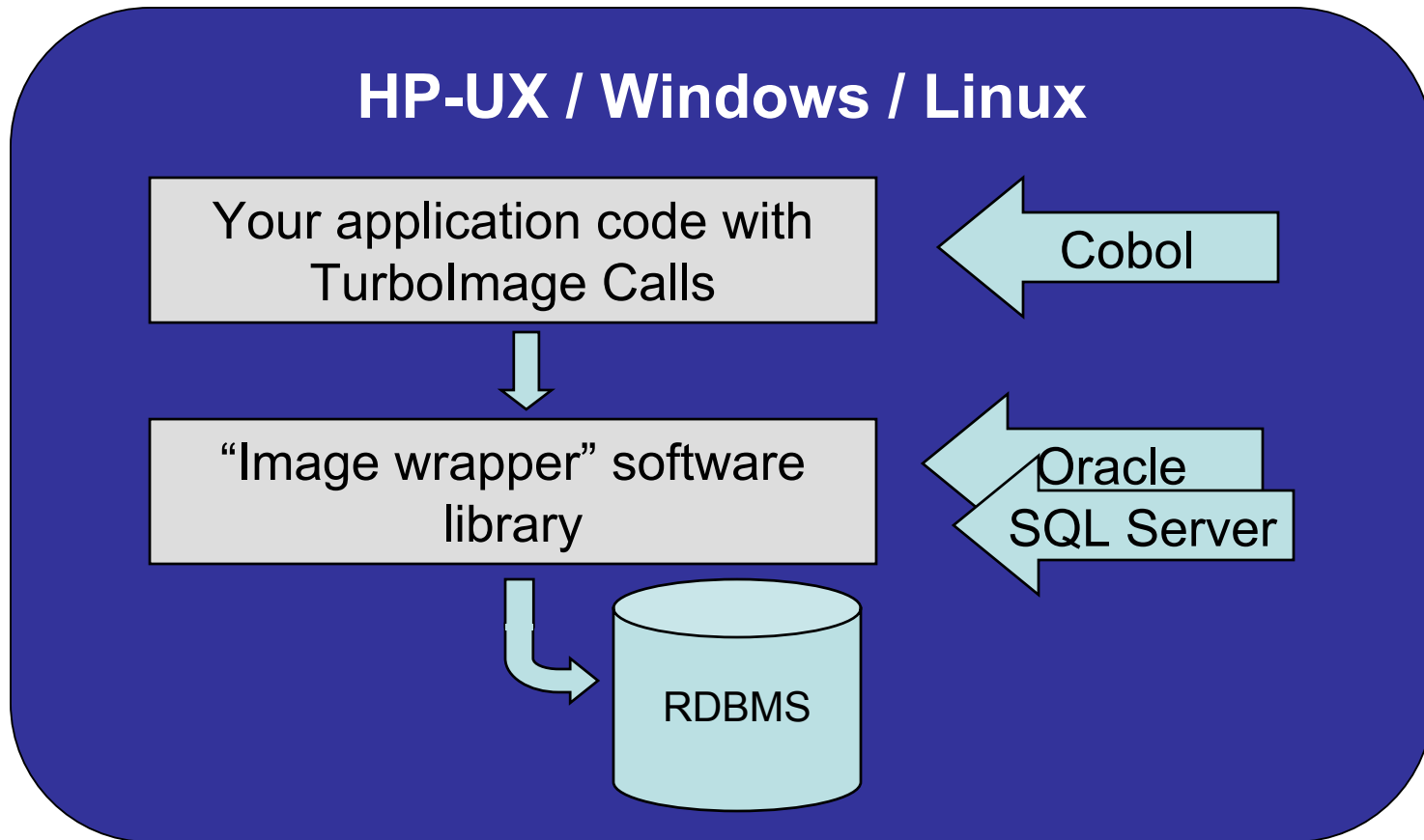

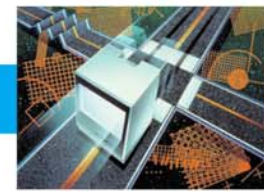

# Redesign Option

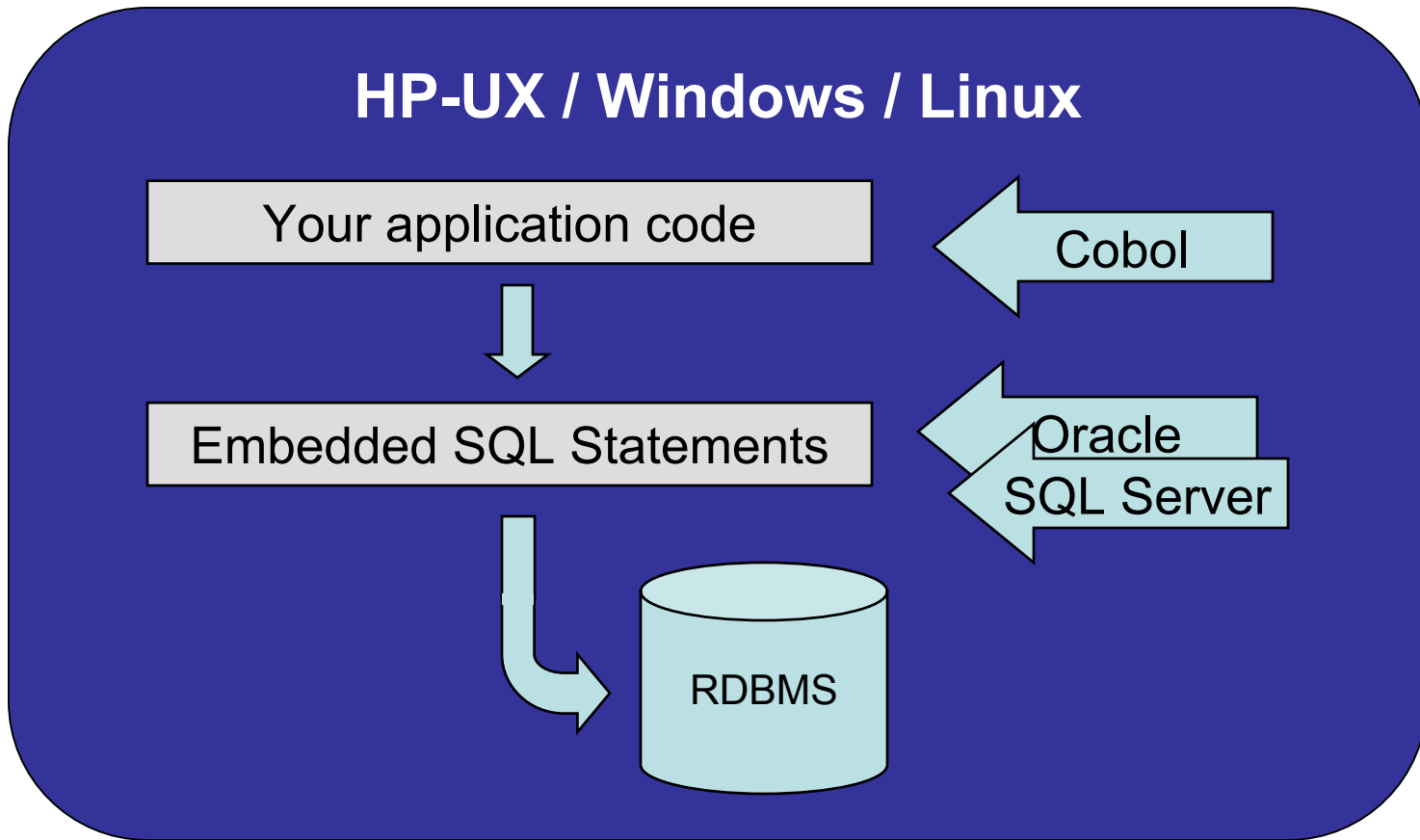

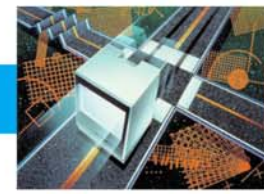

# OS Interaction

- Where the applications touched the OS needs to be dealt with
  - Intrinsic
  - Executing OS Commands
  - JCL
  - Spooler interaction
  - Interacting with the Job queue
  - System variables
  - Hardware device interaction
  - UDCs



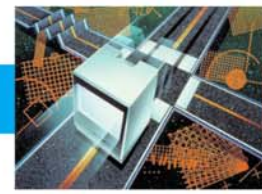

# OS Interaction

- Solutions
  - Replace code with new OS commands / intrinsics / etc.
    - Manual effort
    - Very time consuming
    - Expensive to outsource
  - Use an MPE Emulation product as a translation layer between MPE and the new destination OS commands and utilities
    - Several vendors offer this capability
    - Most support 90%+ of MPE functionality
    - Fastest migration path possible
    - Enables gradual move to native statements
    - There is a \$ cost to using this type of solution

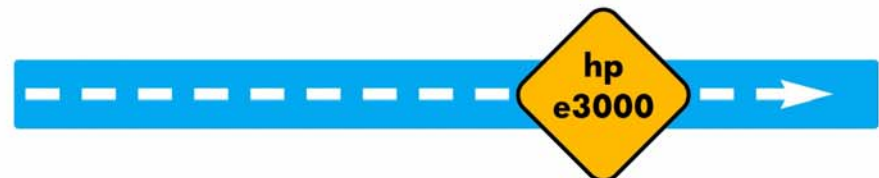

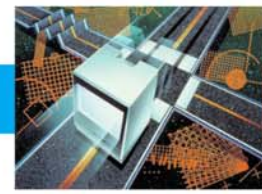

# Other 3GLs

Fortran  
Pascal  
RPG  
C  
SPL  
Business Basic



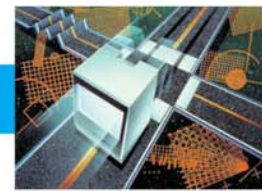

# Fortran

- There are only 2 solutions (Fortran 77 to Fortran 77)
  - ViaNova 3000 (Ordina Denkart)
  - AMXW (Neartek)
- The solution can be determined based on the customers needs
  - Customer wants to do it themselves
    - Best Fit: AMXW (Neartek) is the only solution that is sold as a toolset for customers to do it themselves.
    - Alternative: ViaNova 3000 (Ordina Denkart) is a quick way for someone else to do 90%+ of the migration automation.
      - Finishing work is done manually (no tools)
  - Customer wants it outsourced
    - Best fit: ViaNova 3000 (Ordina Denkart) can provide 100% of the solution upon request.
    - Alternative: Neartek with a Neartek partner can provide a 100% solution.
- VPlus (if used) would have to be treated in the same way as Cobol

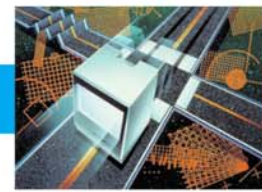

# Pascal

- Pascal is available on the HP-UX platform, however:
  - Will not be supported on IA-64, except in compatibility mode
  - Pascal (HP-UX) will come off HP price list by end of 2002 and will only be supported for 2 years beyond that.
  - Migration is relatively straightforward, but there are no automated tools.
    - MPE / Image Emulation will still be an issue
- Best options:
  - Pascal to C: ViaNova 3000 (Ordina Denkart)
    - Combine with MPUX to get MPE emulation for a quick and clean solution
  - There are other Pascal to C migration tools.
    - Sunguard Bi-Tech has one.

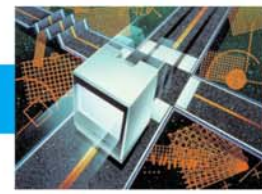

# RPG

- There are 2 solutions for RPG
  - Richter Software has an RPG to HP Cobol migration solution
    - Proven
    - The only solution to really take care of MPE issues
  - There are 2 RPG compilers available for HP-UX, however:
    - There are no migration tools
    - Migration will be very difficult
- RPG on MPE is very bound to the MPE OS and therefore is not very portable to other platforms
  - A migration tool is a must. Therefore, only Richter is a viable option today.

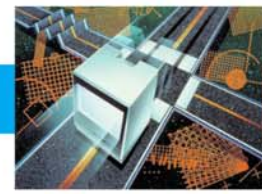

# C

- ViaNova 3000 (Ordina Denkart ) has a migration solution to migrate C to HP-UX or Windows.
  - Combine this with MPUX for MPE Emulation

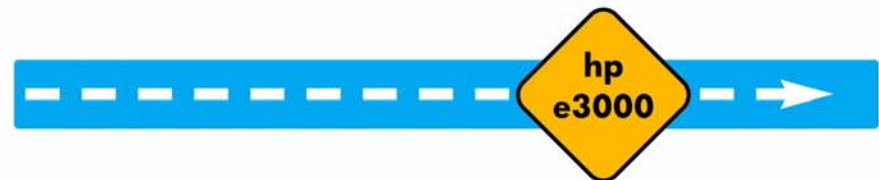

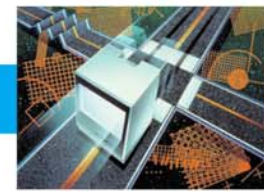

# SPL

- AD Technologies and Allegro are working on a SPLash compiler for HP-UX / Windows / Linux.
- There are 2 known migration solutions that will migrate SPL to C
  - ViaNova 3000 (Denkart)
  - AMXW (Neartek)
  - *Both can also offer MPE emulation*

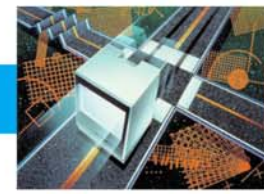

# Business Basic

- The only known option is from Marxmeier Software with the Eloquence product
  - Eloquence comes with Business Basic (that is compatible with the Business Basic on MPE)
    - MPE Emulation would need to be added
    - Could do up to 90% of the job
    - There are some tools to automate the migration process
- An alternative on the PC could be to go to Visual Basic, however, there are no migration tools



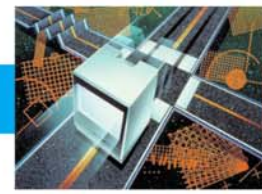

# Automated Migration Solutions

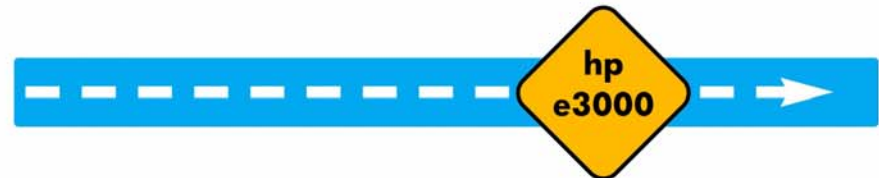

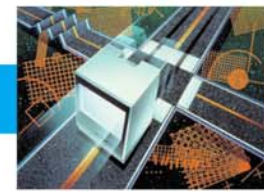

# 3GL Migration Solutions

Cobol (VPLUS)	Denkart, Neartek, Transoft, Sungard Bi-Tech, AD Technologies
Fortran	Fortran 77 on HP-UX Denkart, Neartek
Pascal	Pascal on HP-UX (end-of-support in 2 years) Pascal to C converter (Denkart, Sungard Bi-Tech)
RPG	RPG to HP Cobol Migrator (Richter Software) RPG on HP-UX (no migration tools)
HP Business Basic	Business Basic in Eloquence product Visual Basic (no migration tools)
SPL	Splash on HP-UX (coming soon) SPL to C converter (Denkart)
C	Not really a problem (Denkart)

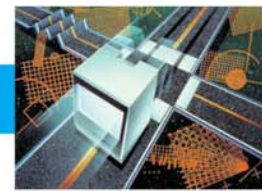

# 3GL Migration Tools

- 4 HP-validated migration solutions
  - Denkart
    - ASP model of migration, charged by number of lines of code, 95% migrated
    - Many 3GL options
  - Neartek
    - Migration tools, packaged and sold as a toolset.
  - Transoft
    - Migration toolset, sold as a consultative solution.
  - Sungard Bi-Tech
    - Migration toolset, sold with consulting, residual run-time libraries for Image and OS calls

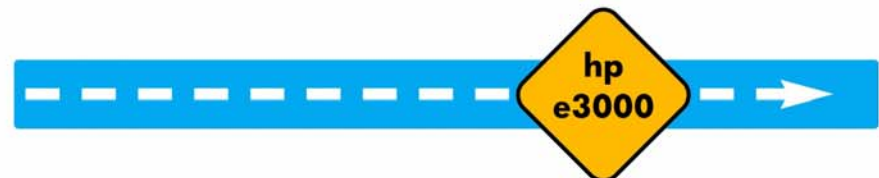

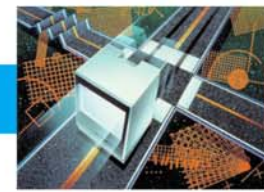

# Ordina Denkart

- ViaNova 3000, plus
  - WingSpan – VPlus emulation on non-MPE systems
  - EdWin – Graphical interface for VPlus emulation
  - MPE Emulation layer
    - Complete and proven
    - Includes support for OS intrinsics, MPE commands, batch jobs and management, spooler, and other MPE utilities.
    - ORDAT is used for DB Intrinsics to Oracle
- Migration of multiple 3GLs
  - To many platforms, incl. HP-UX and Windows
  - HP Cobol to Microfocus Cobol (only)
    - Working on AcuCobol option
  - Fortran 77 to Fortran 77
  - Fortran to C/C++
  - Pascal to C++
  - C to C/C++
  - SPL to C/C++



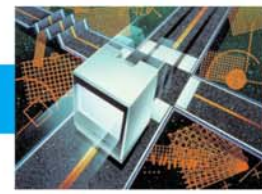

# Ordina Denkart

- Solution is sold in a remote service model
  - Turn around time of basic migration is as short as a few days
  - How it works
    - customer's code is sent to them
    - They run it through an estimator
    - They provide a quote
    - If the customer agrees and signs off, the migration is performed
    - Completed work, along with error reports for what didn't convert are sent back to the customer
      - Customer must complete the work himself, OR
      - Another partner completes the work

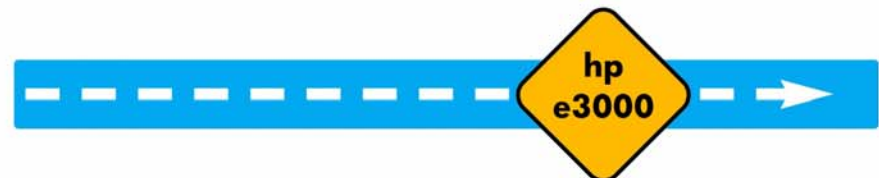

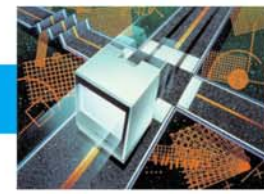

# Neartek

- AMXW
  - Includes an MPE Emulation layer for OS intrinsics, MPE commands, batch jobs, and other MPE utilities.
    - ORDAT is used for DB Intrinsics to Oracle
  - Combines with EdWin (from Ordina Denkart) for VPlus graphical emulation
- Migration of multiple 3GLs
  - HP Cobol to Microfocus Cobol (only)
    - Working on AcuCobol option
  - Fortran 77 to Fortran 77
- Solution is sold as a tool only.
  - Ideal for customers that want to do it themselves
  - Price is based on number of lines of code to be migrated per application



project

- Include Cobol
  - Sources Cobol
    - E\NEARTEK
      - U002U0AQ.cob
      - U014M0EQ.cob
      - U022N0AQ.cob
      - U081E00Q.cob
      - Z077C0CQ.cob
  - Sources Fortran
  - Include SPL
  - Sources SPL
  - Ecrans C Wingspan
    - E\FORM
      - u002a00s.c
      - u014h00s.c
      - z077p00s.c
  - Ecrans H Wingspan
  - Ecrans Cobol Wingspan
  - Schémas bases de donnée
    - E\MIGRE
      - OB000.sch
      - OB077.sch
      - ODUMMY.sch
  - Fichiers JCL

E:\NEARTEK\NEWLAB\MPEXL\E\MIGRE\OB077.SCH

IDENTIFIED BY NEVLAB;

**Options**

Migration      Outils      Rapport de migration

Extension MPE      **Extension NT**      Dossiers

	Clauses copies	cpy
	Include Cobol	cpy
	Sources Cobol	cbl
	Include SPL	h
	Sources SPL	c
	Sources Fortran	f
	Ecrans C Wingspan	c
	Ecrans H Wingspan	h
	Fichiers JCL	jcl
	Schémas bases de donnée	sql
	Ecrans Cobol Wingspan	cbl

Type de base: **SqlServer**

Valider      Annuler

```

MAXEXTENTS 120);
MAXEXTENTS 120);
24      */
24      */
24      */
24      */
24      */
210     */
22      */
22      */

```

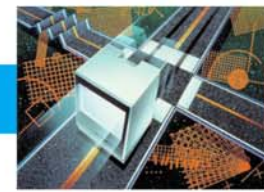

# Transoft

- Solution sold as Consulting Service
- How it works
  - Source code statistics sent to Transoft
  - Quote provided based on code complexity
  - Based on acceptance, code sent to Transoft
  - Converted code installed/tested at customer site with Transoft or PP

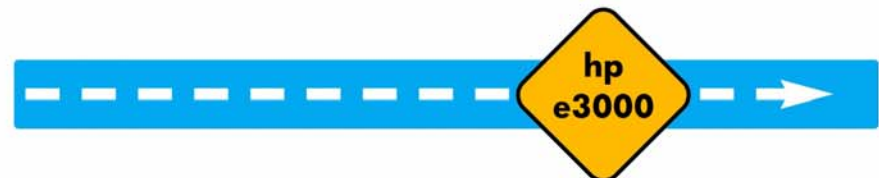



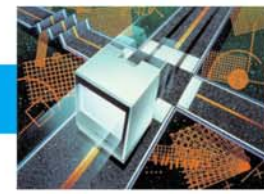

# Transoft Offerings

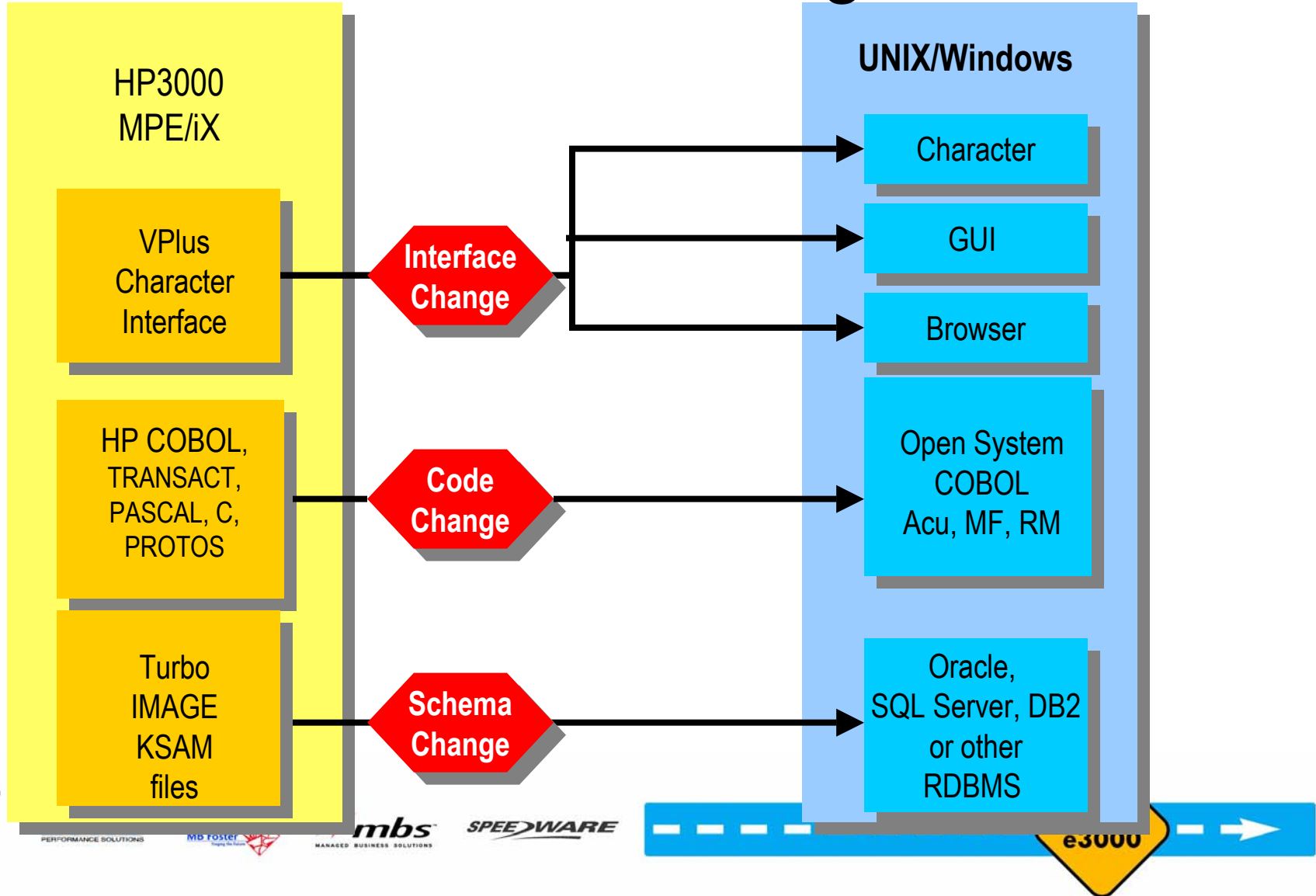

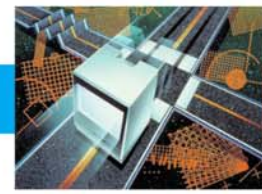

# Sungard Bi-Tech

- Transport
  - HP Cobol to Microfocus Cobol
  - Pascal to C
  - Includes MPE emulation
  - Includes VPlus emulation
- Proven
  - Been used for many years against many applications
- Only sold through a 3<sup>rd</sup> party consulting organization

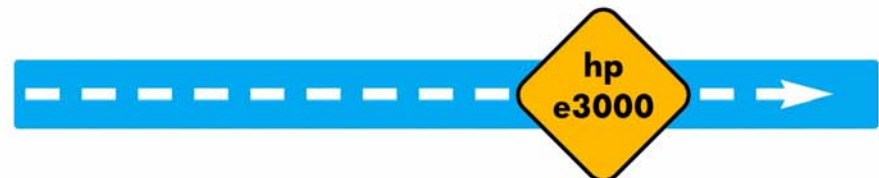

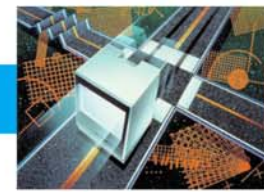

# Richter Software

- RPG to HP Cobol Migrations
  - HP e3000 to HP e3000
  - Going to HP-UX or MPE is a secondary step using the other partners
  - This is the only proven RPG solution
  - Some work may be required after the base migration to clean it up
    - Richter can perform this service for an additional fee based on time and material.
- Solution is sold in a remote service model
  - Turn around time is a few weeks

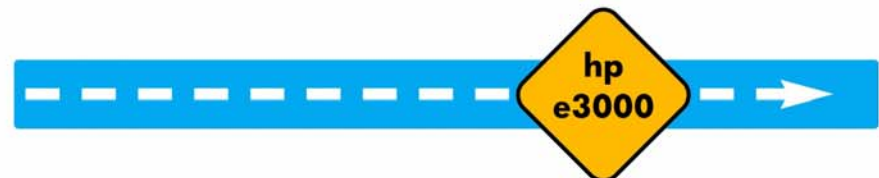

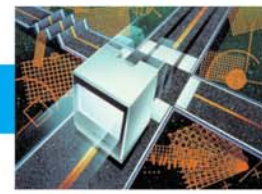

# Selecting a Solution

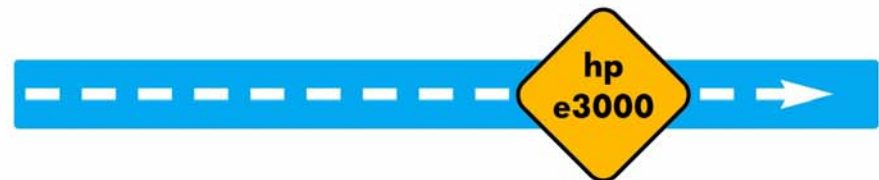

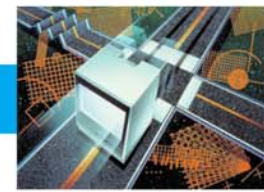

# How To Choose A Solution Vendor?

- Factors that influence vendor choice
  - Time requirements
    - Some are faster than others
  - Resource availability
    - Do they have staff to do any of it themselves?
  - Budget restrictions
    - Some cost more than others
  - End result
    - More native solutions take more time and cost more
    - Faster solutions use run-time emulators
  - Migration Methodology / Technology
  - Strategic IT Direction

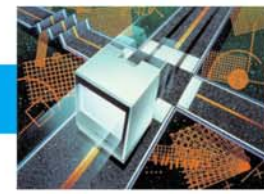

# Cobol examples

- Solution is based on what best fits the customers needs
  - Customer wants to do it themselves
    - Best Fit: AMXW (Neartek) is the only solution that is sold as a toolset for customers to do it themselves.
    - Alternative: ViaNova 3000 (Ordina Denkart) is a quick way for someone else to do 90%+ of the migration automation.
      - Finishing work is done manually (no tools)
  - Customer wants it outsourced
    - Best Fit: Transoft will take 100% control of consulting project from beginning to end.
    - Alternative: ViaNova 3000 (Ordina Denkart) can provide 100% of the solution upon request.
    - Alternative: Neartek with a Neartek partner can provide a 100% solution.

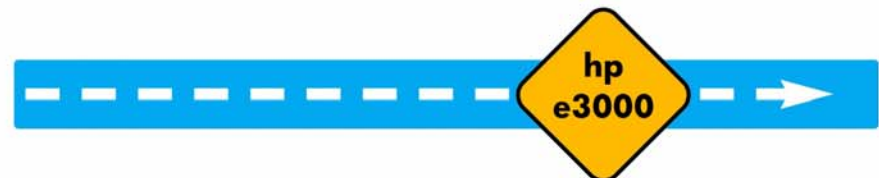

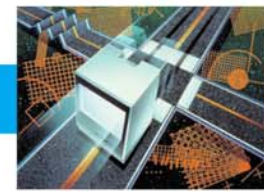

# Cobol examples

- Solution is based on what best fits the customers needs
  - Customer wants it fast
    - Best Fit: ViaNova 3000 (Ordina Denkart) – up to 95% will be done within a couple of days. Total project can be measured in weeks, not months
    - Alternative: AMXW (Neartek) – can be done fast, but you are doing it yourself
  - Customer wants the result as Native as possible (no MPE / Image emulation)
    - Best Fit: Transoft will replace all MPE / Image references with native counterparts, however, this will take longer and cost more.

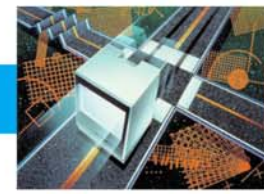

# Cobol

- VPlus Emulations / Solutions
  - EdWin (Ordina Denkart) is a graphical version of VPlus emulation for non-MPE platforms
  - App2XML (Cheops) is a graphical Vplus emulation
  - ExegeClient
  - ScreenJet has a migration toolkit to convert VPlus to AcuBench (AcuCobol)
  - AD Technologies has a migration toolkit to convert VPlus to AcuBench (AcuCobol)
  - Others...
- MPE Emulation
  - Both ViaNova 3000 (Ordina Denkart) and AMXW (Neartek) offer proven MPE emulation products with their migration tools.
    - These products include OS intrinsics, MPE commands, batch jobs, spoolers, and other utilities.
  - Transport (Sunguard Bi-Tech) also has this feature.





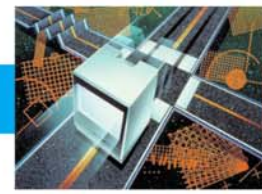

# Final Advice

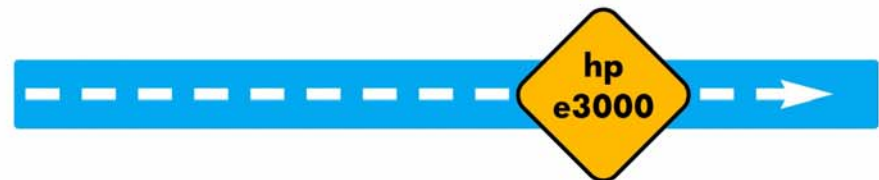

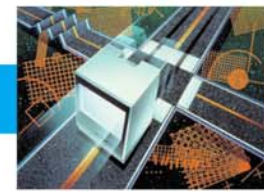

# Final Advice

- Seek advice from Platinum Partners
  - Chosen by HP for their migration and integration expertise
  - They have done the homework on who is good at what
  - Platinum partners offer one-stop shopping for all these tools
  - Think of Platinum partners as “General Contractors”
- Don't under-estimate how many resources it might take
  - Especially for testing
- Choose the right compiler / migration tool combination
  - Clearly identify target, budget, resource constraints, and desired end result.

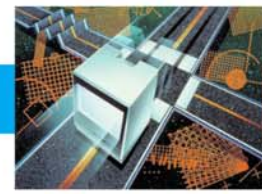

# Thank You

## Questions & Answers

