

# CIFS/9000 Server

## Windows Integration

### Enhancements and Roadmap



**i n v e n t**

Eric Roseme  
Systems Networking Solutions Lab  
Hewlett-Packard

September, 2002



Many organizations deploy Windows clients on their desktops, but prefer the reliability and robustness of UNIX for storing critical data. CIFS/9000 Server utilizes the inherent advantages of HP-UX for data storage, yet provides practical Windows client access while continuing to integrate with Windows 2000 built-in features.



# Agenda – CIFS/9000

## ➤ CIFS/9000 Server review

- samba version tracking
- active directory integration
- authentication
- management
- file system
- name resolution
- DFS

# CIFS/9000 Server Review

- CIFS/9000 Server
  - SMB file/print services on HP-UX
  - Windows client services (98, NT, 2000, XP)
  - Windows domain integration (NT, 2000)
  
- No Added Costs or Licensing
  - Standard Distributed File System on
  - HP-UX Application Release CDs or web ([software.hp.com](http://software.hp.com))



# CIFS/9000 Server Review

- Enterprise File Server and Storage Platform

- Reliability 99.999

- Highly Available: ServiceGuard

- Scalable: rp24X0, rp54X0, rp74X0, rp8400, Superdome

- Storage:

- XP512, XP1024
- VA71xx, VA74xx
- EVA

- Flexibility:

- Dedicated File Servers (or NAS VA and NAS XP)
- Multi-Purpose Servers
- Both (Superdome VPARs)
- Enterprise CIFS and NFS



# Agenda – CIFS/9000

- CIFS/9000 Server review

## ➤ **samba version tracking**

- active directory integration
- authentication
- management
- file system
- name resolution
- DFS

# version tracking

- CIFS/9000 First release, March 2000
  - CIFS/9000 Server A.01.05: Samba 2.0.5
- CIFS/9000 Final 2.0.X release, Sept 2001
  - CIFS/9000 Server A.01.07: Samba 2.0.9
- Current Release (web), March 2002
  - CIFS/9000 Server 2.2a A.01.08: Samba 2.2.3a
  - HP-UX Application Release 0602 (June – CDs)



## version tracking

- Customer Feedback: CIFS/9000 Server should follow Samba releases more closely
- **Top Priority**: Samba platform stability
  - Samba integration schedule dependant upon version reliability
  - HP emphasizes enterprise reliability
- Release Policy Improvement
  - Web releases for improved time to market
  - Interim release (2.2.3a→2.2.5) quicker



# version tracking

- Policy Summary
  - Major version updates – ENSURE STABILITY
    - Ex: 2.0.9-to-2.2.3a
    - Ex: 2.2.5-to-3.0
  - Interim version updates – follow aggressively
    - Ex: 2.0.7-to-2.0.9
    - Ex: 2.2.3a-to-2.2.5

# version tracking

- ***CIFS/9000 Server Technology Preview Release***
  - On [www.software.hp.com](http://www.software.hp.com)
  - Using CIFS/9000 Server product structure
  - Based upon the very latest Samba releases
  - For customer testing – **UNSUPPORTED by HP**

# version tracking

- ***HP-UX Samba Binaries***

- On [http://us1.samba.org/samba/ftp/Binary\\_Packages/hp/](http://us1.samba.org/samba/ftp/Binary_Packages/hp/)
- Latest Samba releases on HP-UX
- **NOT CIFS/9000 Server – HP UNSUPPORTED**
- Compiled with additional Samba compile options
  - --with-winbind
  - --with-pam
- Currently has Samba 2.2.5
- Feedback: What compile options do you want?

# version tracking

- CIFS/9000 Server Samba Roadmap
  - 2.2.5 web release in October 2002
  - Samba 3.0 not released by Samba yet
  - Following progress closely
  - Testing individual features from development code
  - Aspirational goal: early 2003

# Recommendation

- Test with CIFS/9000 Server Technology Preview Release
  - In your test environment
  - Identify version differences of specific interest
  - Send feedback to HP
- Test with HP-UX Samba binaries
  - Install in /usr/local/samba/xxx
  - Can co-exist on CIFS/9000 Server system
  - Great for testing generic Samba features
    - We add more compile options

# Agenda – CIFS/9000

- CIFS/9000 Server review
- samba version tracking

## ➤ active directory integration

- authentication
- management
- file system
- name resolution
- DFS

# active directory integration

- **Our AD Definition:**

- **Directory Server + LDAP**

- Microsoft definition:

- Active Directory Server is Directory Server plus
    - Every integrated feature

- Samba definition:

- Kerberos+DDNS+LDAP

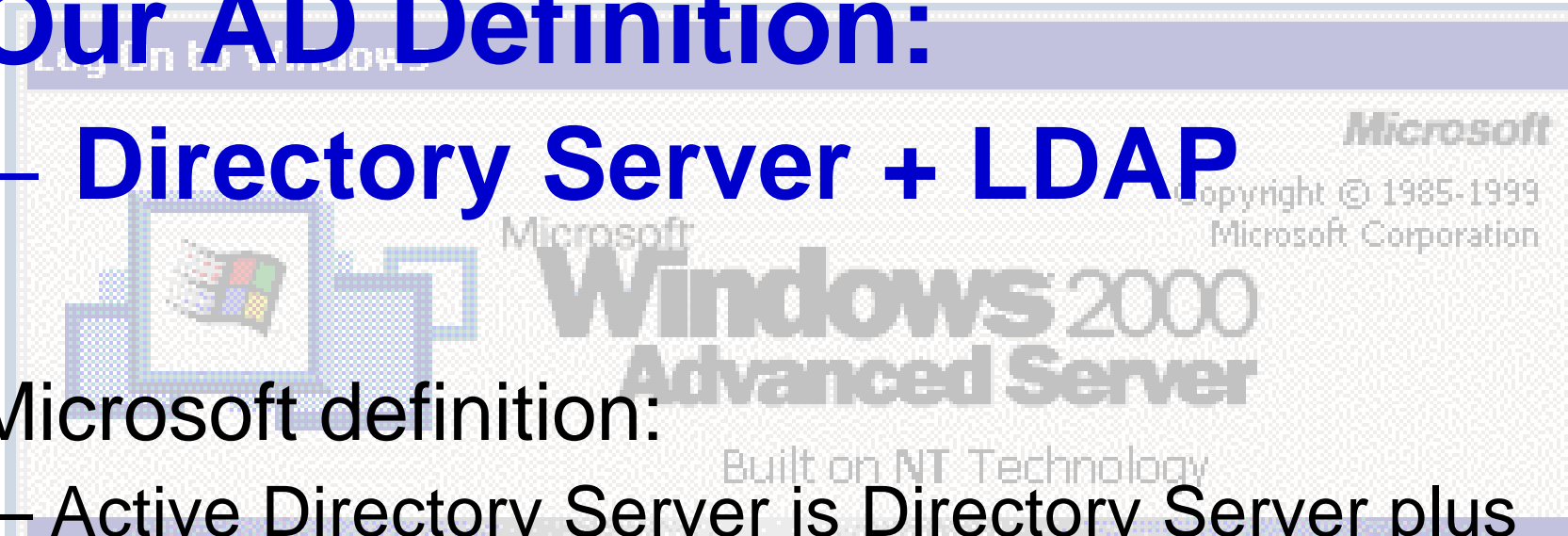

# CIFS/9000 & active directory: **TODAY**

- directory object
  - Member server
  - Mixed mode or native mode
- Read/Write object via MSRPC
- Add object
  - smbpasswd -U on HP-UX
  - MS computer management snap-in
- No real-time ADS writing

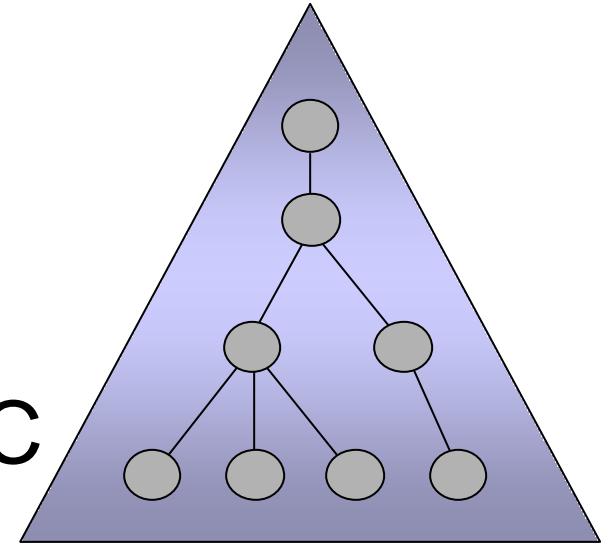



# CIFS/9000 Server ADS object

**dn: CN=hpatcux1,CN=Computers,DC=hpatc,DC=hp,DC=com**

accountExpires: 9223372036854775807

badPasswordTime: 0

badPwdCount: 0

codePage: 0

cn: hpatcux1

countryCode: 0

instanceType: 4

isCriticalSystemObject: FALSE

lastLogoff: 0

lastLogon: 126672436801250000

logonCount: 0

distinguishedName: CN=hpatcux1,CN=Computers,DC=hpatc,DC=hp,DC=com

objectCategory: CN=Computer,CN=Schema,CN=Configuration,DC=hpatc,DC=hp,DC=com

objectClass: top

objectClass: person

objectClass: organizationalPerson

objectClass: user

objectClass: computer

objectGUID:: YAsXyoBE50ecTks+8/lezg==

objectSid:: AQUAAAAAAAAUVAAAAhed+L4F32XSCi6YowgQAAA==

**operatingSystem: Windows NT**

**operatingSystemVersion: 4.0**

primaryGroupID: 515

pwdLastSet: 126672436272187500

name: hpatcux1

sAMAccountName: HPATCUX1\$

sAMAccountType: 805306369

userAccountControl: 4128

uSNChanged: 333886

uSNCreated: 333880

whenChanged: 20020530144707.0Z

whenCreated: 20020530144657.0Z

# Managed From W2000 DC

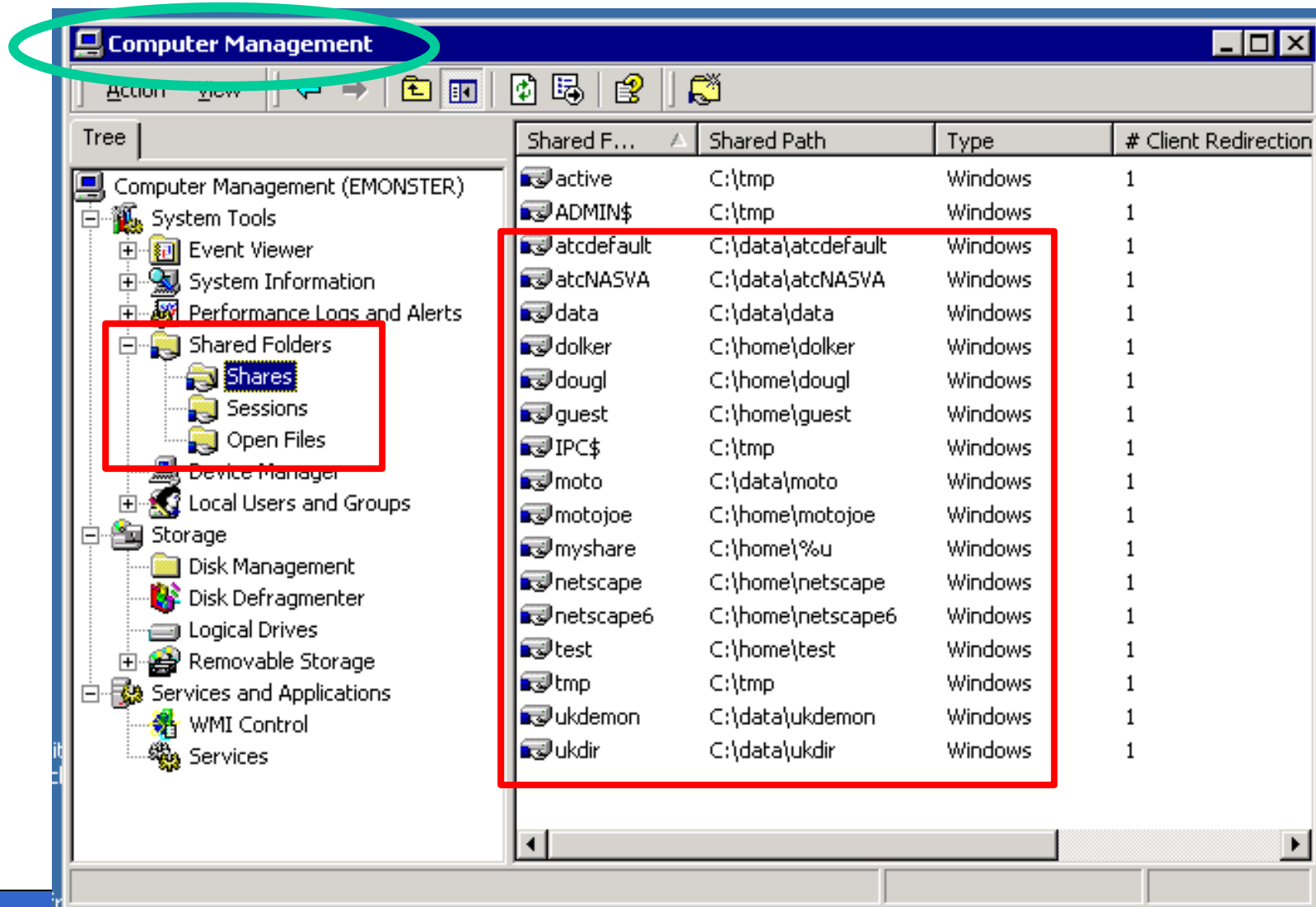

# CIFS/9000 & active directory: **TOMORROW (Samba 3.0)**

- LDAP access to active directory
- Enable real-time directory updates / writes
- “PUBLISH” in active directory
  - Items in “Computer Management” snap-in
  - Printers
- Unknown
  - Global Policy Objects?

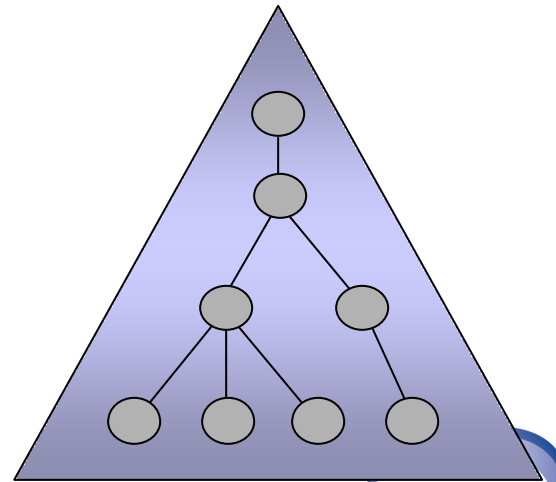

# W2000 Computer object

**dn: CN=HPATCWIN2K2,CN=Computers,DC=hpatc,DC=hp,DC=com**

accountExpires: 9223372036854775807

badPasswordTime: 0

badPwdCount: 0

codePage: 0

cn: HPATCWIN2K2

countryCode: 0

displayName: HPATCWIN2K2\$

dNSHostName: hpatcwin2k2.hpatc.hp.com

instanceType: 4

isCriticalSystemObject: FALSE

lastLogoff: 0

lastLogon: 126675944540937500

localPolicyFlags: 0

logonCount: 33

distinguishedName: CN=HPATCWIN2K2,CN=Computers,DC=hpatc,DC=hp,DC=com

objectCategory: CN=Computer,CN=Schema,CN=Configuration,DC=hpatc,DC=hp,DC=com

objectClass: top

objectClass: person

objectClass: organizationalPerson

objectClass: user

objectClass: computer

objectGUID:: 1FFNrgAHBUq1/ObWFTib9Q==

objectSid:: AQUAAAAAAAAUVAAAAhed+L4F32XSCi6YovwQAAA==

**operatingSystem: Windows 2000 Server**

**operatingSystemServicePack: Service Pack 2**

**operatingSystemVersion: 5.0 (2195)**

primaryGroupID: 515

pwdLastSet: 126664859035625000

name: HPATCWIN2K2

sAMAccountName: HPATCWIN2K2\$

sAMAccountType: 805306369

servicePrincipalName: HOST/HPATCWIN2K2

servicePrincipalName: HOST/hpatcwin2k2.hpatc.hp.com

userAccountControl: 4096

uSNChanged: 331207

# Managed from W2000 DC

The screenshot shows the Windows Computer Management console. The title bar is circled in green. In the left-hand tree view, the 'Shares' folder under 'Shared Folders' is selected and highlighted with a green box, with a red arrow pointing to it. The main pane displays a table of active shares, also enclosed in a green box. The table has the following data:

Shared Folder	Shared Path	Type	# Client Redirections	Comment
ADMIN\$	C:\WINNT	Windows	0	Remote Ad
C\$	C:\	Windows	0	Default sha
hpatc_shr3	C:\hpatc_shr3	Windows	2	
PC\$		Windows	1	Remote IPC
temp	C:\temp	Windows	1	

stop-start shares

# Managed from W2000 DC

The screenshot shows the Windows Computer Management console. The title bar is circled in green. The left-hand tree view is also outlined in green, with a red arrow pointing to the 'Sessions' folder. The main pane displays a table of active sessions.

User	Computer	Type	Open Files	Connected Time	Idle Time	Guest
	15.32.72.207	Windows	0	00:00:37	00:00:37	No
ADMINISTRATOR	15.43.211.70	Windows	1	00:00:00	00:00:00	No
EROSEME	SNSLATC-DC	Windows	2	01:56:12	00:03:20	No
EROSEME	15.32.72.207	Windows	1	00:08:44	00:00:37	No

disconnect sessions

# Managed from W2000 DC

The screenshot shows the Windows Computer Management console. The title bar is circled in green and contains the text "Computer Management". The left-hand "Tree" pane shows a hierarchy of system tools, with "Open Files" under "Shared Folders" highlighted in blue and pointed to by a red arrow. The main pane displays a table of open files.

Open File	Accessed By	Type	# Locks	Open Mode
\PIPE\svsvsc	ADMINISTRATOR	Windows	0	Write+Read
C:\hpatc_shr3	EROSEME	Windows	0	Read
C:\hpatc_shr3	EROSEME	Windows	0	Read
C:\temp	EROSEME	Windows	0	Read

close open files

# AD Integration Recommendation

- Computer Management feature
- Important to administration tasks?
- What other AD management tasks?
- Group Policy Objects?



# Agenda – CIFS/9000

- CIFS/9000 Server review
- samba version tracking
- active directory integration

## ➤ authentication

- management
- file system
- name resolution
- DFS

# NTLM and Kerberos

- NTLM Today
  - Server - NTLM v1
    - CIFS/9000 Server A.01.08, Samba 2.2.3a
  - Client - domain login with Kerberos
- Kerberos Tomorrow
  - Server - Kerberos
    - CIFS/9000 Server, Samba 3.0
    - Currently prototype testing
  - Client **and** Server use Kerberos
- Also
  - NTLM v2 at Samba 3.0



# Today: NTLM Review

- CIFS/9000 Authenticates using NT4.0 **NTLM v1**
- Authentication is pass-through (domain mode)
- CIFS/9000 can co-exist in a W2000 domain with Kerberos W2000 *client* logins!
  - EVEN IN NATIVE MODE!
- W2000 Domain Security with CIFS/9000
  - W2000 Clients = **Kerberos**
  - CIFS/9000 Servers = **NTLM v1**

## NTLM Review

# W2000 Client Logon with Kerberos

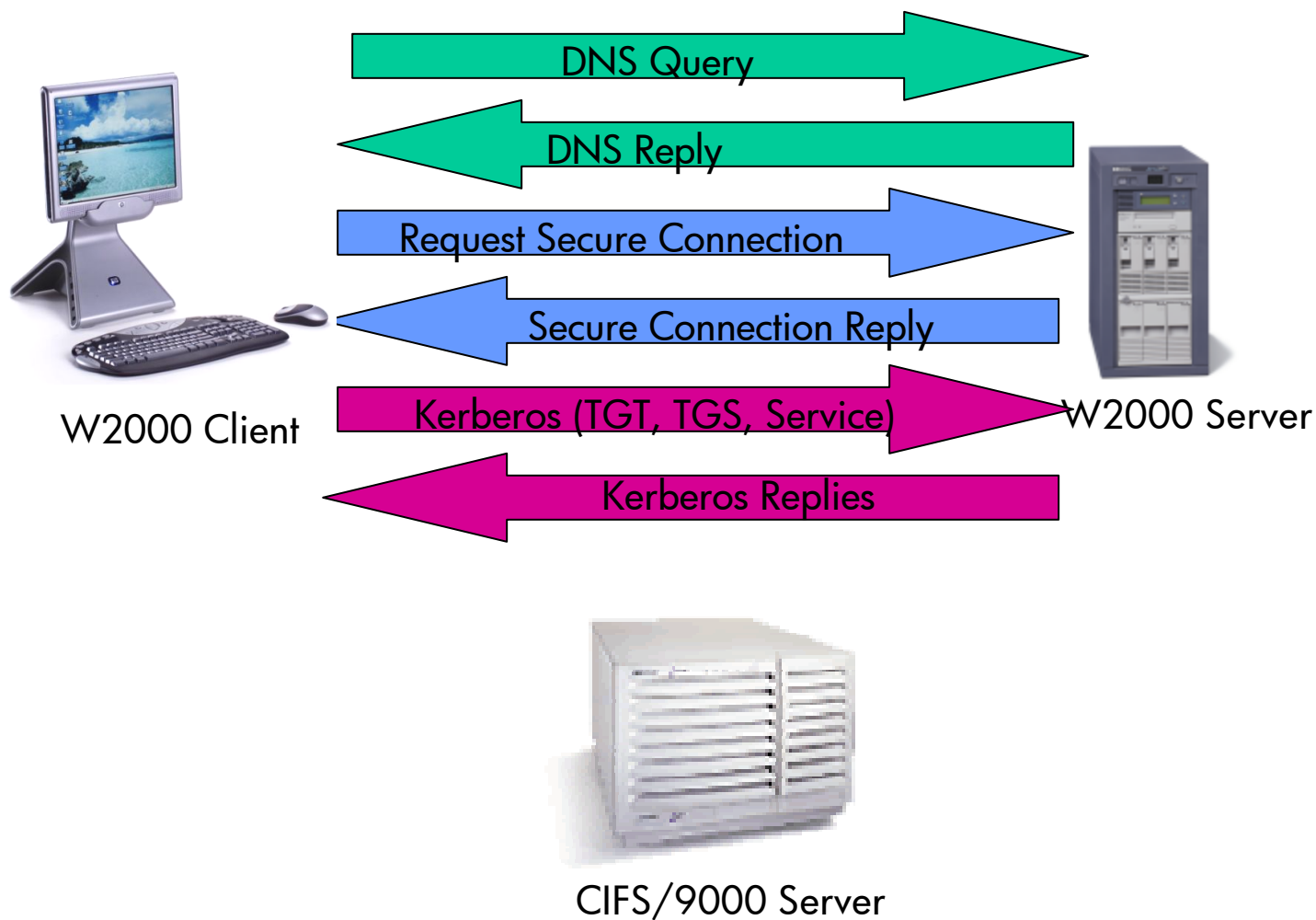

# NTLM Review

# Client Logon - Kerberos

F...	Protocol	Description	Src Other ...	Dst Other ...	Type Oth...
44	TCP	.A...., len: 0, seq:3945702047...	ROS87208ERIC	hpatcwin2k	IP
45	DNS	0x2:Std Qry for _kerberos._tcp.De...	ROS87208ERIC	hpatcwin2k	IP
46	DNS	0x2:Std Qry Resp. for _kerberos._...	hpatcwin2k	ROS87208ERIC	IP
47	LDAP	ProtocolOp: SearchRequest (3)	ROS87208ERIC	hpatcwin2k	IP
48	LDAP	ProtocolOp: SearchResponse (4)	hpatcwin2k	ROS87208ERIC	IP
49	TCP	.A...., len: 0, seq:3945812196...	ROS87208ERIC	hpatcwin2k	IP
50	KERBEROS	KRB_AS_REQ	ROS87208ERIC	hpatcwin2k	IP
51	KERBEROS	KRB_AS_REP	hpatcwin2k	ROS87208ERIC	IP
52	KERBEROS	KRB_TGS_REQ	ROS87208ERIC	hpatcwin2k	IP
53	KERBEROS	KRB_TGS_REP	hpatcwin2k	ROS87208ERIC	IP
54	KERBEROS	KRB_TGS_REQ	ROS87208ERIC	hpatcwin2k	IP
55	KERBEROS	KRB_TGS_REP	hpatcwin2k	ROS87208ERIC	IP
56	SMB	C session setup & X	ROS87208ERIC	hpatcwin2k	IP
57	NDP	SS: Session Message 6.6t., 1242 B...	ROS87208ERIC	hpatcwin2k	IP
58	TCP	.A...., len: 0, seq:2175427613...	hpatcwin2k	ROS87208ERIC	IP
59	SMB	R session setup & X	hpatcwin2k	ROS87208ERIC	IP
60	SMB	C tree connect & X, Share = \\HPA...	ROS87208ERIC	hpatcwin2k	IP
61	SMB	R tree connect & X, Type = y	hpatcwin2k	ROS87208ERIC	IP
62	SMB	C transact2 NT Get DFS Referral	ROS87208ERIC	hpatcwin2k	IP
63	SMB	R transact2 NT Get DFS Referral (...	hpatcwin2k	ROS87208ERIC	IP
64	TCP	.A...., len: 0, seq:3945750555...	ROS87208ERIC	hpatcwin2k	IP
65	ICMP	Echo: From 15.32.72.207 To 15.32....	ROS87208ERIC	hpatcwin2k	IP
66	ICMP	Echo Reply: To 15.32.72.207 From ...	hpatcwin2k	ROS87208ERIC	IP
67	LDAP	ProtocolOp: SearchRequest (3)	ROS87208ERIC	hpatcwin2k	IP
68	LDAP	ProtocolOp: SearchResponse (4)	hpatcwin2k	ROS87208ERIC	IP
69	TCP	....S., len: 0, seq:3947220928...	ROS87208ERIC	hpatcwin2k	IP
70	TCP	.A..S., len: 0, seq:2176725727...	hpatcwin2k	ROS87208ERIC	IP
71	TCP	.A...., len: 0, seq:3947220929...	ROS87208ERIC	hpatcwin2k	IP
72	MSRPC	c/o RPC Bind: UUID E1AF83...	ROS87208ERIC	hpatcwin2k	IP
73	MSRPC	c/o RPC Bind Ack: call 0x1 a...	hpatcwin2k	ROS87208ERIC	IP
74	MSRPC	c/o RPC Request: call 0x1 o...	ROS87208ERIC	hpatcwin2k	IP
75	MSRPC	c/o RPC Response: call 0x1 c...	hpatcwin2k	ROS87208ERIC	IP
76	TCP	.A...F, len: 0, seq:3947221157...	ROS87208ERIC	hpatcwin2k	IP
77	TCP	.A...., len: 0, seq:2176725940...	hpatcwin2k	ROS87208ERIC	IP
1	DNS	0x1:Std Qry for ldap.tcp.Default...	ROS87208ERIC	hpatcwin2k	IP

# NTLM Review

## W2000 Map CIFS Drive - NTLM

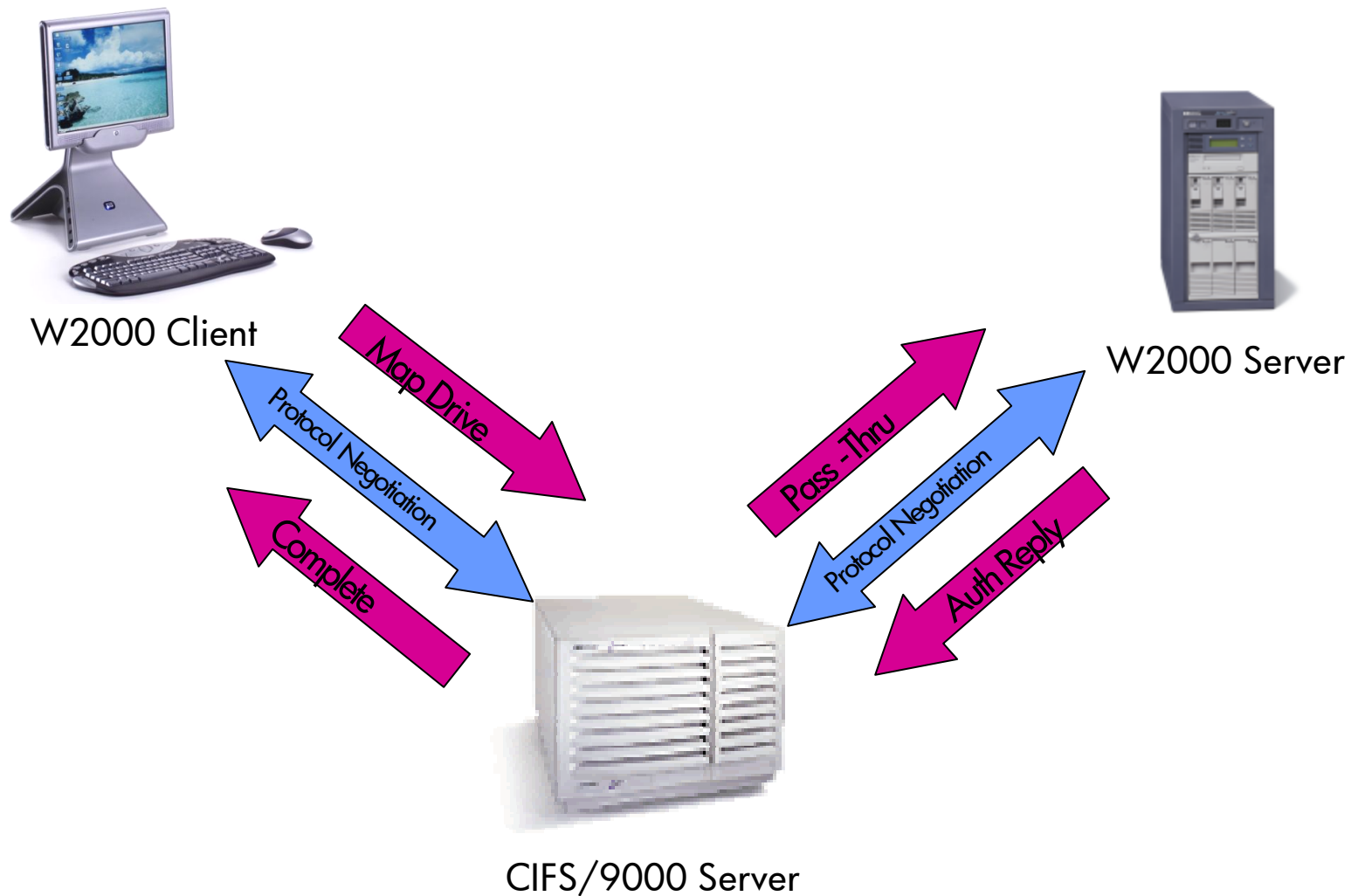

# NTLM Review

# W2000-CIFS/9000 Pass-Thru

Microsoft Network Monitor - [D:\data\ericR\ATC\CIFS\Presentation\Interworks\_2001\inter2001\_logon\_map\_dom1.cap (Summary)]

File Edit Display Tools Options Window Help

Frame	Time	Src MAC Addr	Dst MAC Addr	Protocol	Description	Src Other Addr	Dst Other Addr	Type
102	32.465712	EMONSTER	LOCAL	NBT	SS: Session Message Cont., 11 Bytes	EMONSTER	ROS87208ERIC	IP
103	32.465712	LOCAL	EMONSTER	TCP	...S., len: 0, seq:2176972608-217697260...	ROS87208ERIC	EMONSTER	IP
104	32.465712	EMONSTER	LOCAL	TCP	.A..S., len: 0, seq:1835371842-183537184...	EMONSTER	ROS87208ERIC	IP
105	32.465712	LOCAL	EMONSTER	TCP	.A...., len: 0, seq:2176972609-217697260...	ROS87208ERIC	EMONSTER	IP
106	32.465712	LOCAL	EMONSTER	NBT	SS: Session Request, Dest: EMONSTER	ROS87208ERIC	EMONSTER	IP
107	32.525797	EMONSTER	LOCAL	NBT	SS: Positive Session Response, Len: 0	EMONSTER	ROS87208ERIC	IP
108	32.525797	LOCAL	EMONSTER	SMB	C negotiate, Dialect = NT LM 0.12	ROS87208ERIC	EMONSTER	IP
109	32.525797	EMONSTER	LOCAL	SMB	R negotiate, Dialect # = 5	EMONSTER	ROS87208ERIC	IP
110	32.535811	LOCAL	EMONSTER	SMB	C session setup & X, Username = , and C tre...	ROS87208ERIC	EMONSTER	IP
111	32.545825	EMONSTER	LOCAL	SMB	R session setup & X, and R tree connect & X...	EMONSTER	ROS87208ERIC	IP
112	32.555839	LOCAL	ROS872520LK	KERBEROS	KRB_TGS_REQ	ROS87208ERIC	ROS872520LK	IP
113	32.555839	ROS872520LK	LOCAL	KERBEROS	KRB_ERROR	ROS872520LK	ROS87208ERIC	IP
114	32.555839	LOCAL	EMONSTER	SMB	C session setup & X, Username = eroseme, an...	ROS87208ERIC	EMONSTER	IP
115	32.565853	ROS872520LK	EMONSTER	NBT	NS: Query (Node Status) resp. for DOM1	ROS872520LK	EMONSTER	IP
116	32.615924	EMONSTER	LOCAL	TCP	.A...., len: 0, seq:1835372018-183537201...	EMONSTER	ROS87208ERIC	IP
117	32.836234	EMONSTER	ROS872520LK	NBT	NS: Query req. for *SMBSERVER	EMONSTER	ROS872520LK	IP
118	32.836234	ROS872520LK	EMONSTER	NBT	NS: Query (Node Status) resp. for *SMBSERVE...	ROS872520LK	EMONSTER	IP
119	32.846248	EMONSTER	ROS872520LK	TCP	...S., len: 0, seq:1835661563-183566156...	EMONSTER	ROS872520LK	IP
120	32.846248	ROS872520LK	EMONSTER	TCP	.A..S., len: 0, seq:3986722425-398672242...	ROS872520LK	EMONSTER	IP
121	32.856262	EMONSTER	ROS872520LK	TCP	.A...., len: 0, seq:1835661564-183566156...	EMONSTER	ROS872520LK	IP
122	33.356967	EMONSTER	ROS872520LK	NBT	SS: Session Request, Dest: ROS872520LK	EMONSTER	ROS872520LK	IP
123	33.356967	ROS872520LK	EMONSTER	NBT	SS: Positive Session Response, Len: 0	ROS872520LK	EMONSTER	IP
124	33.356967	EMONSTER	ROS872520LK	SMB	C negotiate, Dialect = NT LM 0.12	EMONSTER	ROS872520LK	IP
125	33.356967	ROS872520LK	EMONSTER	SMB	R negotiate, Dialect # = 7	EMONSTER	ROS872520LK	IP
126	33.356967	EMONSTER	ROS872520LK	SMB	C session setup & X, Username =	EMONSTER	ROS872520LK	IP
127	33.356967	ROS872520LK	EMONSTER	SMB	R session setup & X	EMONSTER	EMONSTER	IP
128	33.356967	EMONSTER	ROS872520LK	SMB	C tree connect & X, Share = \\ROS872520LK\IPC	EMONSTER	ROS872520LK	IP
129	33.356967	ROS872520LK	EMONSTER	SMB	R tree connect & X, type = IPC	ROS872520LK	EMONSTER	IP
130	33.356967	EMONSTER	ROS872520LK	SMB	C NT create & X, File = NETLOGON	EMONSTER	ROS872520LK	IP
131	33.356967	ROS872520LK	EMONSTER	SMB	R NT create & X, FID = 0x4000	ROS872520LK	EMONSTER	IP
132	33.356967	EMONSTER	ROS872520LK	MSRPC	c/o RPC Bind: UUID 12345678-1234-AB...	EMONSTER	ROS872520LK	IP
133	33.356967	ROS872520LK	EMONSTER	MSRPC	c/o RPC Bind Ack: call 0x1 assoc grp 0...	ROS872520LK	EMONSTER	IP
134	33.356967	EMONSTER	ROS872520LK	R_LOGON	RPC Client call logon:NetrServerReqChalleng...	EMONSTER	ROS872520LK	IP
135	33.356967	ROS872520LK	EMONSTER	R_LOGON	RPC Server response logon:NetrServerReqChal...	EMONSTER	ROS872520LK	IP
136	33.356967	EMONSTER	ROS872520LK	R_LOGON	RPC Client call logon:NetrServerAuthenticat...	EMONSTER	ROS872520LK	IP
137	33.366981	ROS872520LK	EMONSTER	R_LOGON	RPC Server response logon:NetrServerAuthent...	EMONSTER	EMONSTER	IP
138	33.366981	EMONSTER	ROS872520LK	R_LOGON	RPC Client call logon:NetrLogonSamLogon(..)	EMONSTER	ROS872520LK	IP
139	33.366981	ROS872520LK	EMONSTER	R_LOGON	RPC Server response logon:NetrLogonSamLogon...	EMONSTER	ROS872520LK	IP
140	33.366981	EMONSTER	ROS872520LK	SMB	C close file, FID = 0x4000	EMONSTER	ROS872520LK	IP
141	33.366981	ROS872520LK	EMONSTER	SMB	R close file	ROS872520LK	EMONSTER	IP

Network Monitor V5.00.943 F#: 1/235 Off: 0(x0) L: 0(x0)

Client to CIFS/9000 Server

CIFS/9000 Server to W2000 DC

# Tomorrow: Full Kerberos

- CIFS/9000 Server registers with KDC
- Client authenticates with KDC
- Client requests CIFS/9000 Server ticket
  - From W2000 KDC
- Client presents ticket to CIFS/9000 Server
- CIFS/9000 Server authorizes client



# Register CIFS/9000 with KDC



W2000 Client

register principal

generate keytab



W2000 KDC



CIFS/9000 Server

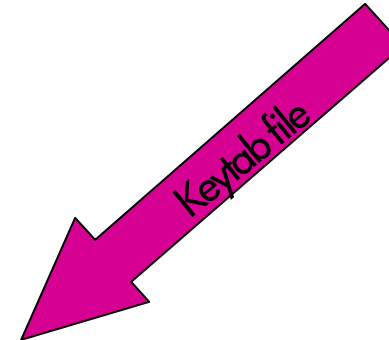

# Register CIFS/9000 with KDC

1. Register
2. Generate keytab
3. Transfer keytab
  - On CIFS/9000 Server root:
    - *root>net ads join*
  - New “net” command *performs all 3*
    - From CIFS/9000 server
    - No KDC admin session required

# W2000 Client Logon with Kerberos

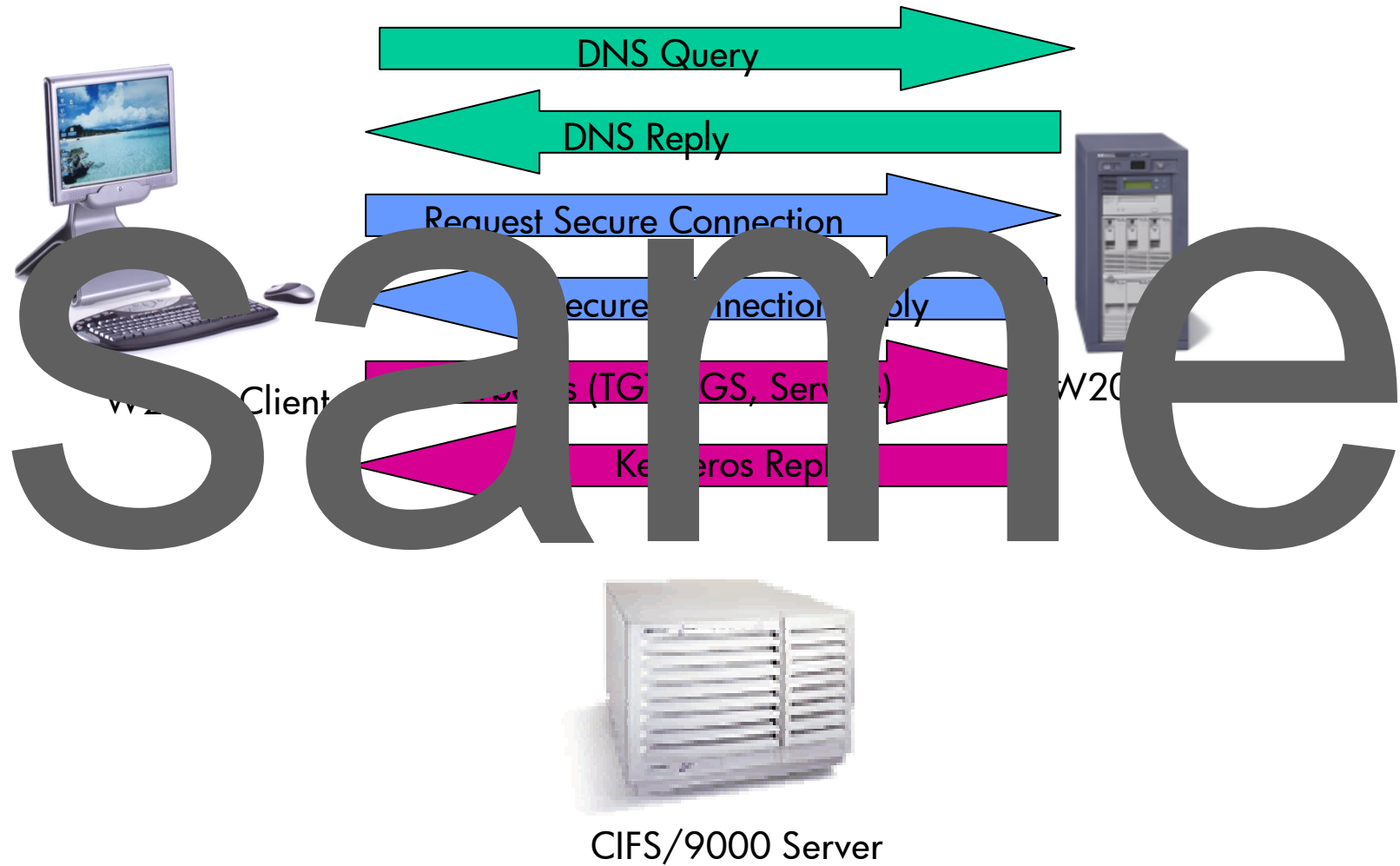

# Authorize Client - Kerberos

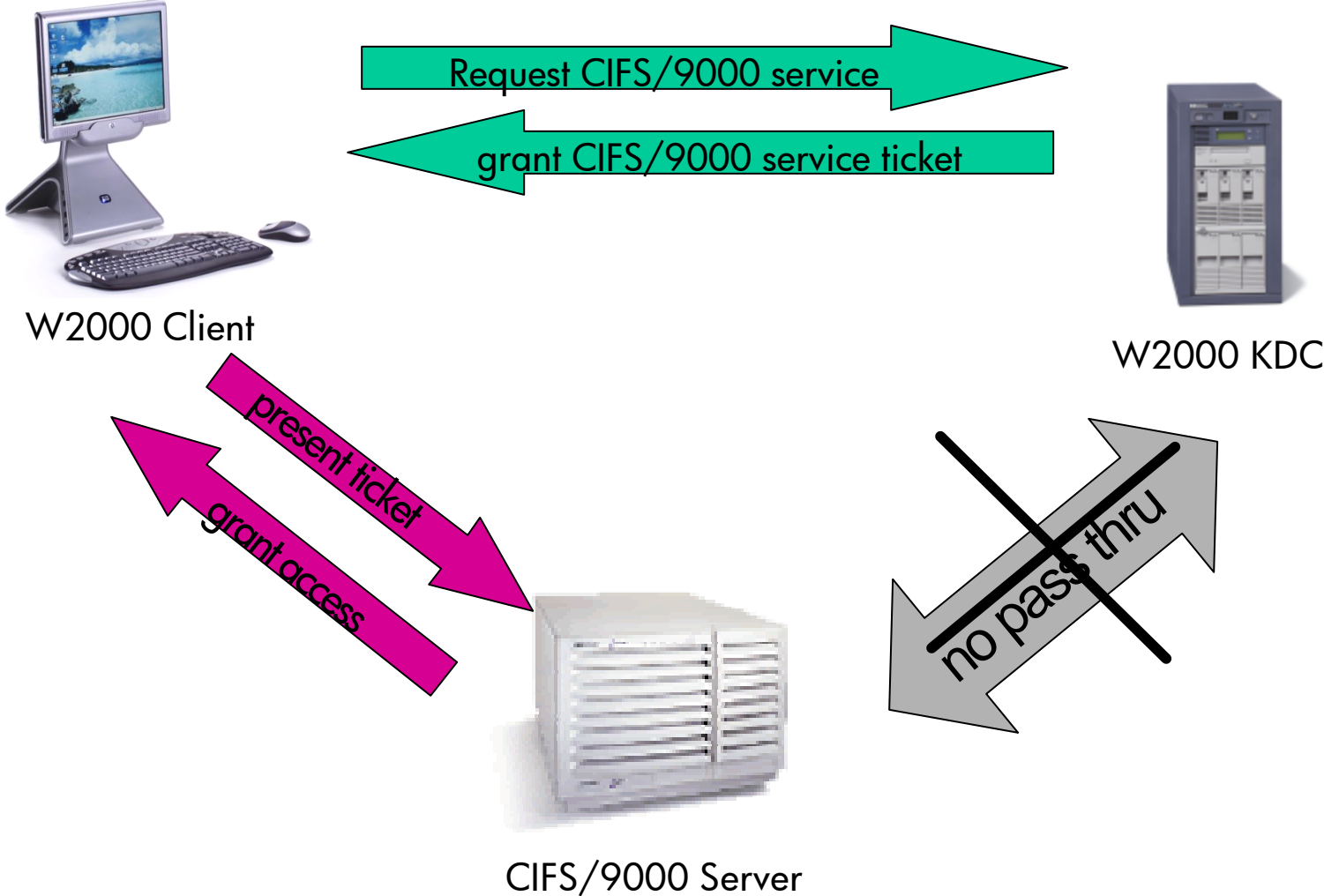

# W2000-W2000 Kerberos Example

Microsoft Network Monitor - [C:\WINNT\system32\NetmonFull\Captures\kerb\_2k2\_2k3.cap (Summary)]

File Edit Display Tools Options Window Help

Frame	Protocol	Description	Src Other Addr	Dst Other Addr	Type
28	KERBEROS	KRB_TGS_REQ	HPATCWIN2K2	hpatcwin2k	IP
29	KERBEROS	KRB_TGS_REP	hpatcwin2k	HPATCWIN2K2	IP
30	SMB	C session setup & X	HPATCWIN2K2	hpatcwin2k3	IP
31	SMB	R session setup & X	hpatcwin2k3	HPATCWIN2K2	IP
32	SMB	C tree connect & X, Share = \\HPATCWIN2K3\IPC\$	HPATCWIN2K2	hpatcwin2k3	IP
33	SMB	R tree connect & X, Type = 0	hpatcwin2k3	HPATCWIN2K2	IP
34	SMB	C transact2 NT Get DFS Referral	HPATCWIN2K2	hpatcwin2k3	IP
35	SMB	R transact2 - NT error, System, Error, Code = (14)...	hpatcwin2k3	HPATCWIN2K2	IP
36	KERBEROS	KRB_TGS_REQ	HPATCWIN2K2	hpatcwin2k	IP
37	KERBEROS	KRB_TGS_REP	hpatcwin2k	HPATCWIN2K2	IP
38	SMB	C session setup & X	HPATCWIN2K2	hpatcwin2k3	IP
39	NBT	SS: Session Message Cont., 110 Bytes	HPATCWIN2K2	hpatcwin2k3	IP
40	TCP	.A...., len: 0, seq:1828795798-1828795798, ack:...	hpatcwin2k3	HPATCWIN2K2	IP
41	SMB	R session setup & X	hpatcwin2k3	HPATCWIN2K2	IP
42	SMB	C tree connect & X, Share = \\HPATCWIN2K3\THE_BRONZE	HPATCWIN2K2	hpatcwin2k3	IP
43	SMB	R tree connect & X, Type = 0	hpatcwin2k3	HPATCWIN2K2	IP
44	TCP	.A...., len: 0, seq:3770126615-3770126615, ack:...	HPATCWIN2K2	hpatcwin2k3	IP
45	SMB	C NT create & X, File = \Desktop.ini	HPATCWIN2K2	hpatcwin2k3	IP
46	SMB	R NT create & X - NT error, System, Error, Code = ...	hpatcwin2k3	HPATCWIN2K2	IP
47	SMB	C NT create & X, File = \Desktop.ini	HPATCWIN2K2	hpatcwin2k3	IP
48	SMB	R NT create & X - NT error, System, Error, Code = ...	hpatcwin2k3	HPATCWIN2K2	IP
49	SMB	C transact2 NT Get DFS Referral	HPATCWIN2K2	hpatcwin2k3	IP
50	SMB	R transact2 - NT error, System, Error, Code = (14)...	hpatcwin2k3	HPATCWIN2K2	IP
51	SMB	C tree connect & X, Share = \\HPATCWIN2K3\THE_BRONZE	HPATCWIN2K2	hpatcwin2k3	IP
52	SMB	R tree connect & X, Type = 0	hpatcwin2k3	HPATCWIN2K2	IP
53	SMB	C NT create & X, File = \Desktop.ini	HPATCWIN2K2	hpatcwin2k3	IP
54	SMB	R NT create & X - NT error, System, Error, Code = ...	hpatcwin2k3	HPATCWIN2K2	IP
55	SMB	C transact2 Query path info, File =	HPATCWIN2K2	hpatcwin2k3	IP
56	SMB	R transact2 Query path info (response to frame 55)	hpatcwin2k3	HPATCWIN2K2	IP

Server Message Block (SMB) F#: 30/81 Off: 58 (x3A) L: 1428 (x594)

Client to W2000 DC - get the ticket

Client to file Server - here is my ticket (uses SMB to present ticket)

# Authentication summary

- Current and future: NTLM
- Soon: full Kerberos authentication
  - At Samba 3.0 integration
- Client, DC, CIFS/9000 server – all Kerberos
- Mixed or Native mode
- Easy configuration
- Transparent to users

# Agenda – CIFS/9000

- CIFS/9000 Server review
- samba version tracking
- active directory integration
- authentication

## ➤ management

- file system
- name resolution
- DFS

# CIFS/9000 Server Management

- Key management issue: System Administrators
  - UNIX admins in a Windows domain
  - Windows admins on a UNIX server
- Management Integration Methods
  1. Default Samba-CIFS/9000 Server admin
  2. HP-UX Unified Login
  3. winbind





# 1: Default Samba-CIFS/9000 Admin

- **smb.conf**
- **Samba Web Administration Tool (SWAT)**
- **Sync Windows and UNIX users and groups**
  - **Windows user = UNIX user**
    - User “cordelia” on both OSes (UNIX – 8 char max)
  - **Map users with username.map file**
    - **cordelia.chase = cordelia**
  - **Build matching group structure on UNIX**
- **Repeat process for each CIFS/9000 Server**

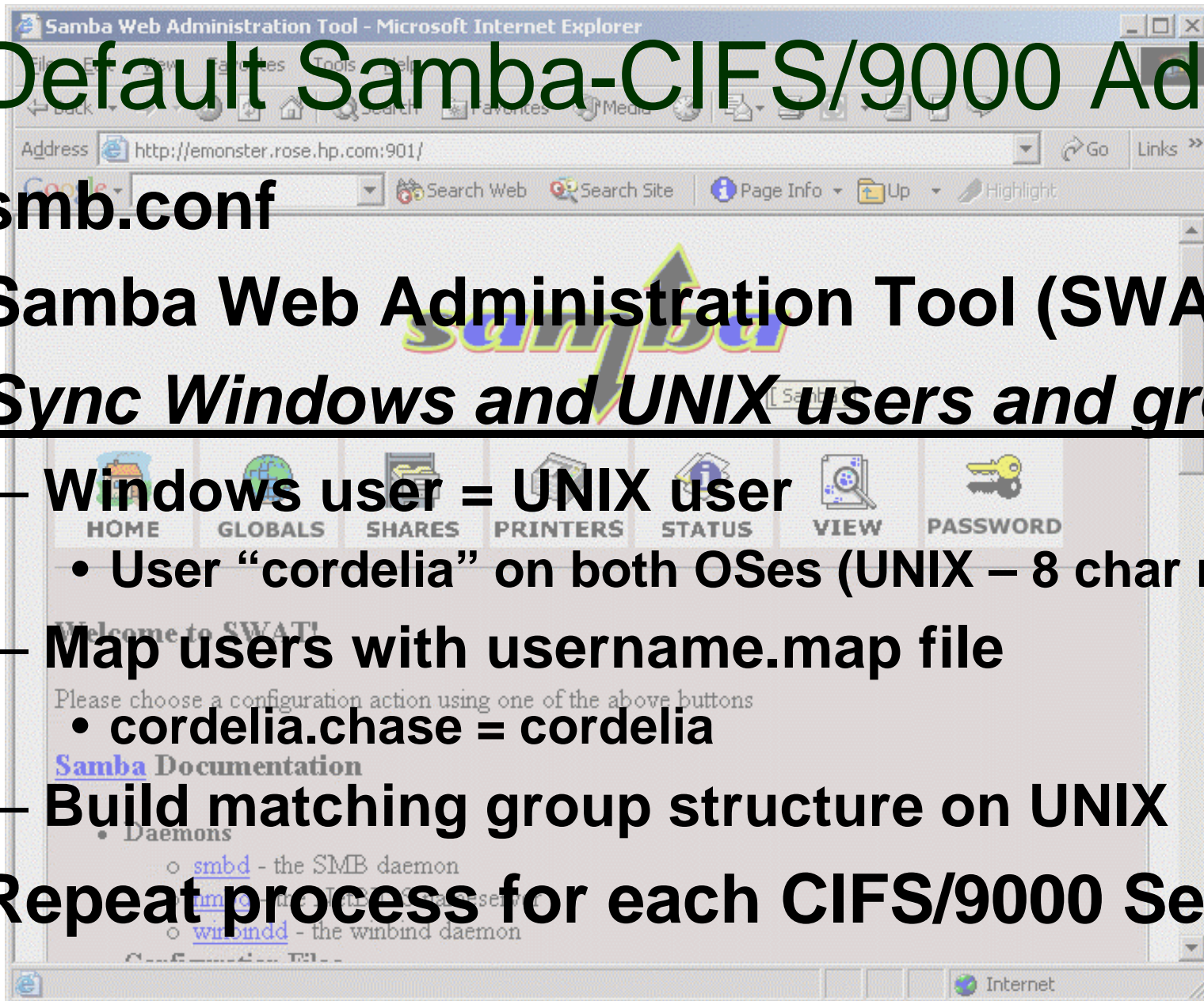

# 1: Default Samba-CIFS/9000 Admin

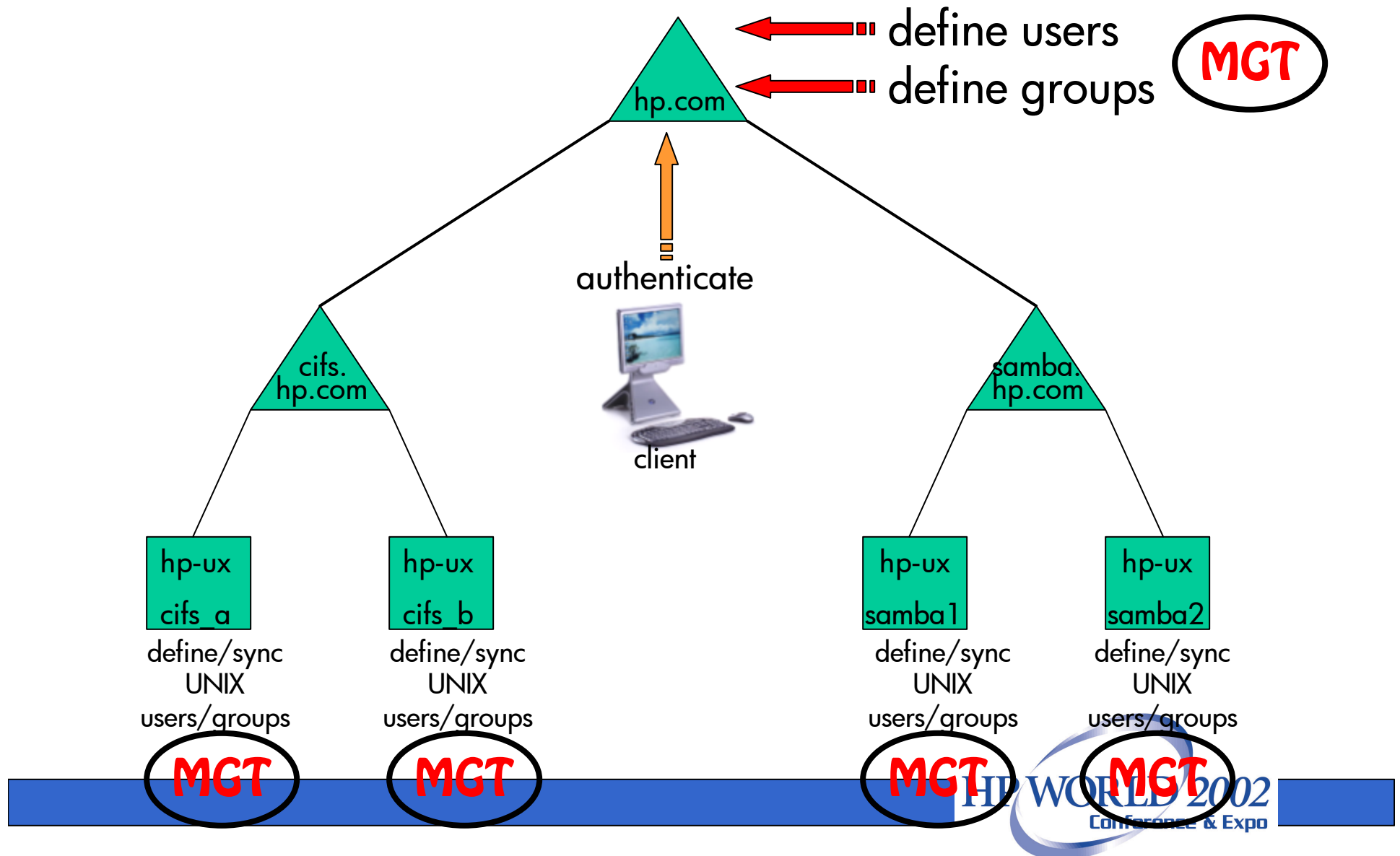

# 1: How It Works

conceptual diagram  
not code-accurate

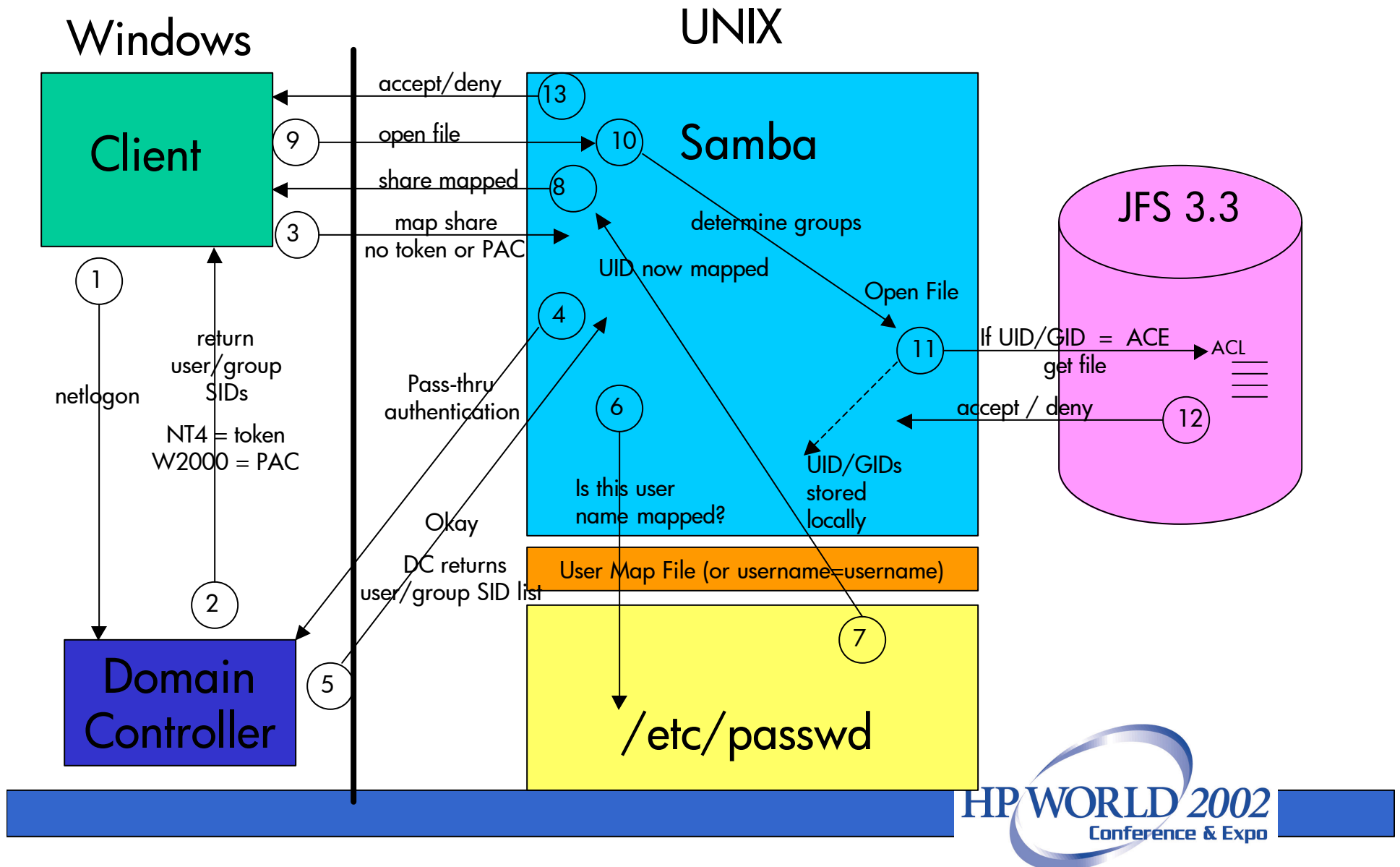

## 2: HP-UX Unified Login

- HP-UX to W2000 Active Directory, using
  - nsswitch
  - pam\_ldap
- W2000 admin tools manage HP-UX users/groups
  - W2000 user = HP-UX user: on same ADS object
  - W2000 group = HP-UX group: on same ADS object
- Shared user/group structure
- Shared management tools
- Same user/group account source for all CIFS servers

## 2: HP-UX Unified Login

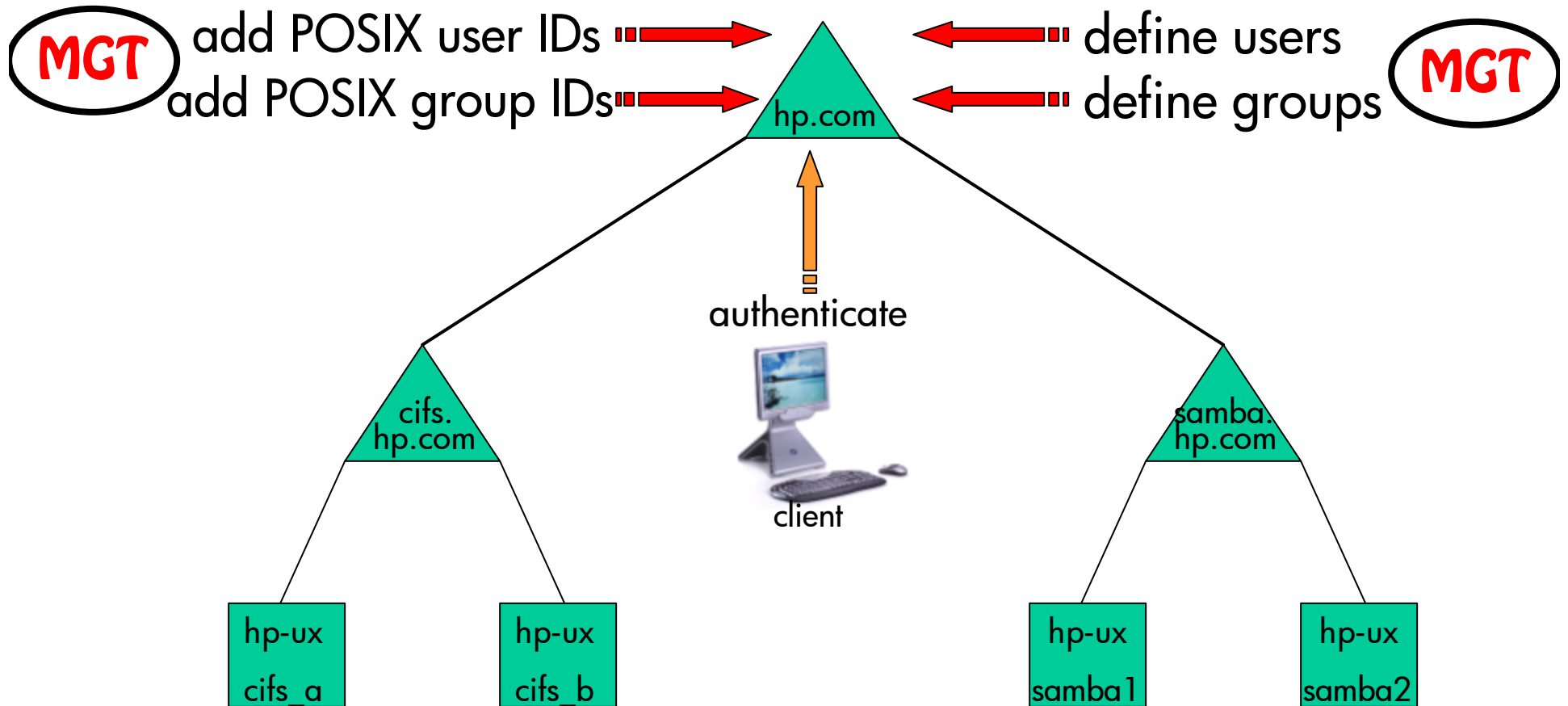

users/groups recoverable, in sync, displayable

# HP-UX Unified Login: admin tools

**Cordelia Chase Properties**

Member Of | Dial-in | Environment | Sessions  
General | Address | Account | Profile | Telephones | Organization  
Remote control | Terminal Services Profile | UNIX Attributes

To enable access to this user for UNIX clients, you will have to specify the NIS domain this user belongs to.

NIS Domain:

UID:

Login Shell:

Home Directory:

Primary group name/GID:

OK Cancel Apply

- User Object
  - W2000 Admin tools
  - Standard User
  - UNIX Attributes tab
  - UNIX UID Defined
  - Login Shell
  - UNIX Primary Group
  
  - Combines Windows and UNIX user account attributes in User Object

# ADS User Object

dn: CN=Cordelia Chase,OU=Users,OU=LDAP-UX,DC=hpatc,DC=hp,DC=com  
cn: Cordelia Chase  
displayName: Cordelia Chase  
distinguishedName: CN=Cordelia Chase,OU=Users,OU=LDAP-UX,DC=hpatc,DC=hp,DC=com  
objectCategory: CN=Person,CN=Schema,CN=Configuration,DC=hpatc,DC=hp,DC=com  
objectClass: top  
objectClass: person  
objectClass: organizationalPerson  
objectClass: user  
objectGUID:: heRlz2wjXE2llefQH17TXw==  
objectSid:: AQUAAAAAAAAUVA AAAhed+L4F32XSCi6YosAQAAA==  
primaryGroupID: 513  
pwdLastSet: 126618094701562500  
name: Cordelia Chase  
sAMAccountName: cordelia  
sAMAccountType: 805306368  
sn: Chase  
userAccountControl: 66048  
userPrincipalName: cordelia@hpatc.hp.com  
gidNumber: 1021  
loginShell: /bin/sh  
msSFUHomeDirectory: /home/cordelia  
msSFUName: cordelia  
syncNisDomain: hpatc  
uidNumber: 1003

# HP-UX Unified Login: admin Tools

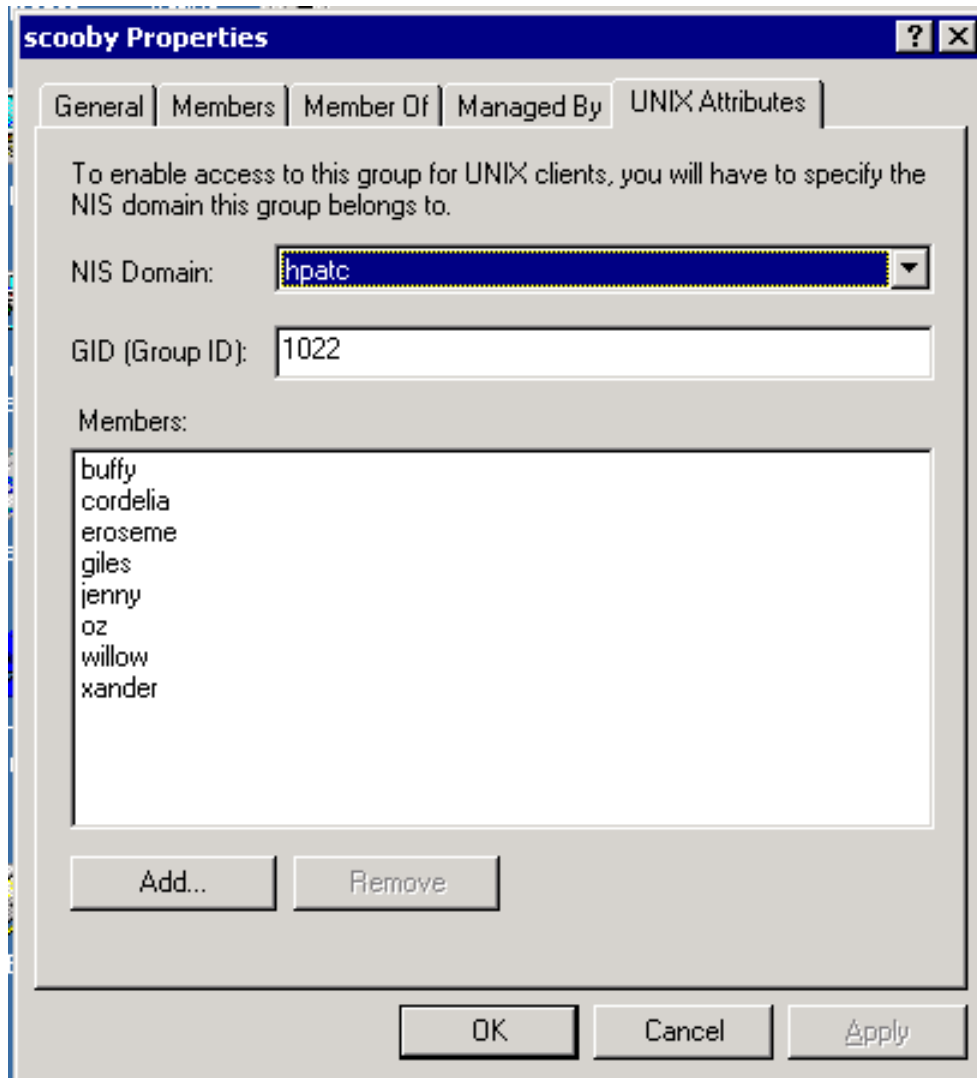

- Group Object
  - W2000 Admin tools
  - Standard Group
  - Unix Attributes tab
  - UNIX GID Defined
  - UNIX Users defined in group
  - Combines Windows and UNIX Account Attributes in Group Object



# ADS Group Object (old)

dn: CN=scooby,OU=Groups,OU=LDAP-UX,DC=hpatc,DC=hp,DC=com  
member: CN=Xander Harris,OU=Users,OU=LDAP-UX,DC=hpatc,DC=hp,DC=com  
member: CN=Jenny Calendar,OU=Users,OU=LDAP-UX,DC=hpatc,DC=hp,DC=com  
member: CN=Rupert Giles,OU=Users,OU=LDAP-UX,DC=hpatc,DC=hp,DC=com  
member: CN=Willow Rosenberg,OU=Users,OU=LDAP-UX,DC=hpatc,DC=hp,DC=com  
member: CN=Daniel Osborn,OU=Users,OU=LDAP-UX,DC=hpatc,DC=hp,DC=com  
member: CN=Cordelia Chase,OU=Users,OU=LDAP-UX,DC=hpatc,DC=hp,DC=com  
member: CN=Buffy Summers,OU=Users,OU=LDAP-UX,DC=hpatc,DC=hp,DC=com  
member: CN=Eric Roseme,OU=Users,OU=LDAP-UX,DC=hpatc,DC=hp,DC=com

cn: scooby

distinguishedName: CN=scooby,OU=Groups,OU=LDAP-UX,DC=hpatc,DC=hp,DC=com

objectCategory: CN=Group,CN=Schema,CN=Configuration,DC=hpatc,DC=hp,DC=com

objectClass: group

objectGUID:: wAoA1CAwT02nhp1yZr3xgA==

objectSid:: AQUAAAAAAAAUVAAAAhed+L4F32XSCi6YosQQAAA==

name: scooby

sAMAccountName: scooby

gidNumber: 1022

memberUid: oz

memberUid: giles

memberUid: jenny

memberUid: xander

memberUid: willow

memberUid: cordelia

memberUid: eroseme

memberUid: buffy

msSFUName: scooby

syncNisDomain: hpatc

# ADS Group Object (new)

- LDAP-UX 3.0 (0902 HP-UX AR)
  - Uses distinguished name
  - msSFU memberUID not required

```
dn: CN=scooby,OU=Groups,OU=LDAP-UX,DC=hpatc,DC=hp,DC=com
member: CN=Xander Harris,OU=Users,OU=LDAP-UX,DC=hpatc,DC=hp,DC=com
member: CN=Jenny Calendar,OU=Users,OU=LDAP-UX,DC=hpatc,DC=hp,DC=com
member: CN=Rupert Giles,OU=Users,OU=LDAP-UX,DC=hpatc,DC=hp,DC=com
member: CN=Willow Rosenberg,OU=Users,OU=LDAP-UX,DC=hpatc,DC=hp,DC=com
member: CN=Daniel Osborn,OU=Users,OU=LDAP-UX,DC=hpatc,DC=hp,DC=com
member: CN=Cordelia Chase,OU=Users,OU=LDAP-UX,DC=hpatc,DC=hp,DC=com
member: CN=Buffy Summers,OU=Users,OU=LDAP-UX,DC=hpatc,DC=hp,DC=com
member: CN=Eric Roseme,OU=Users,OU=LDAP-UX,DC=hpatc,DC=hp,DC=com
cn: scooby
distinguishedName: CN=scooby,OU=Groups,OU=LDAP-UX,DC=hpatc,DC=hp,DC=com
objectCategory: CN=Group,CN=Schema,CN=Configuration,DC=hpatc,DC=hp,DC=com
objectClass: group
objectGUID:: wAoA1CAwT02nhp1yZr3xgA==
objectSid:: AQUAAAAAAAAUVAAAhed+L4F32XSCi6YosQQAAA==
name: scooby
sAMAccountName: scooby
gidNumber: 1022
msSFUName: scooby
syncNisDomain: hpatc
```

# 2: How it Works

conceptual diagram  
not code-accurate

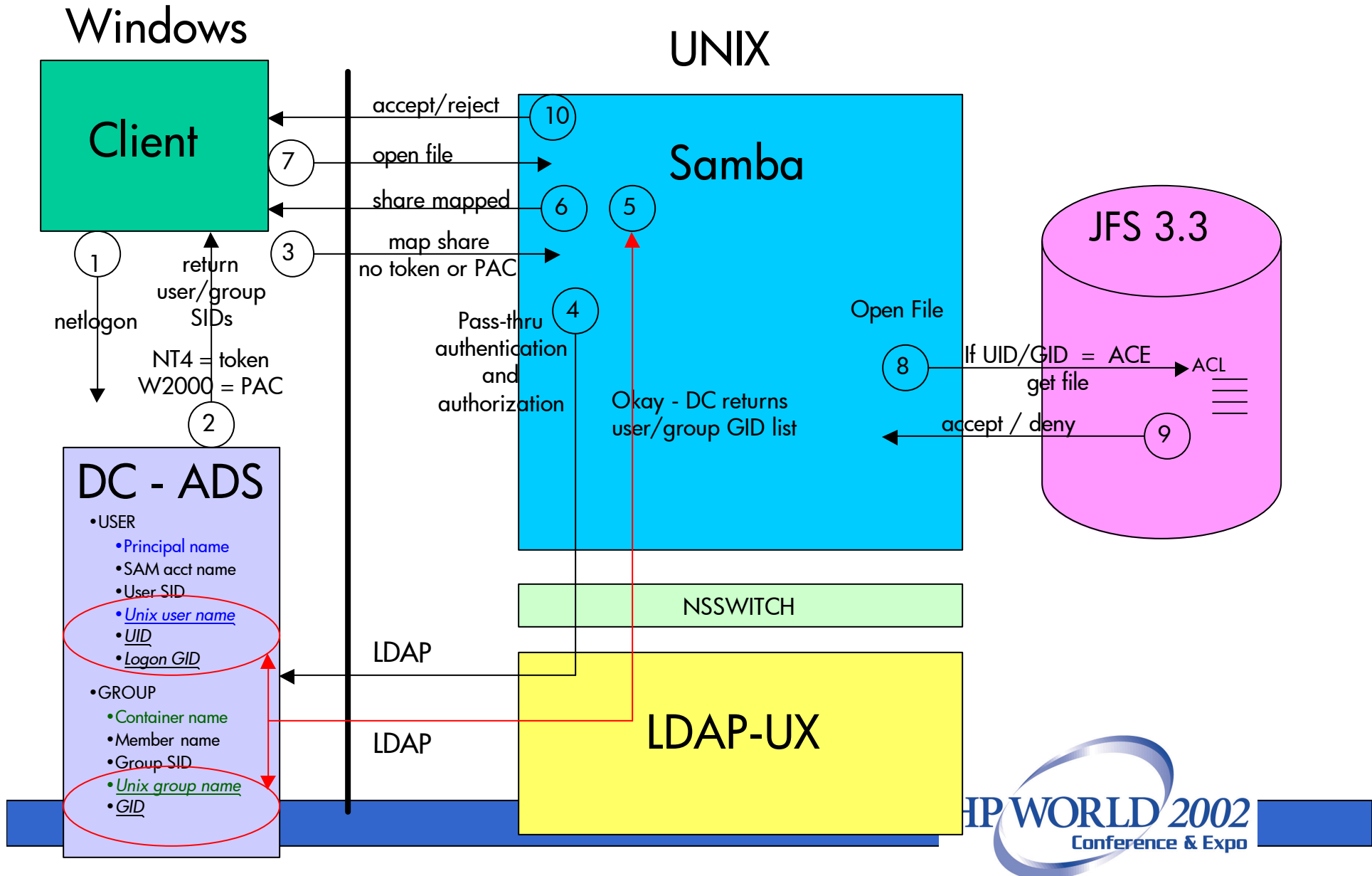

# Unified Login: More Info

- Whitepaper
  - <http://www.docs.hp.com/hpux/onlinedocs/internet/ADSLDUX.pdf>
- Presentation
  - On HPWorld 2001 CD
  - <http://www.interex.org/conference/hpworld2001/sessions/sn159/>
- Installation Manual
  - <http://www.docs.hp.com/hpux/pdf/J4269-90014.pdf>

## 3: winbind

- Samba automatic mapping utility
- Runs as a separate process (winbind daemon)
- Maps Windows users/group SIDs to UID/GID
- Stores mappings in a tdb (tiny database) file
- Manage users/groups on Windows only
- Simplifies user/group administration

# 3: winbind

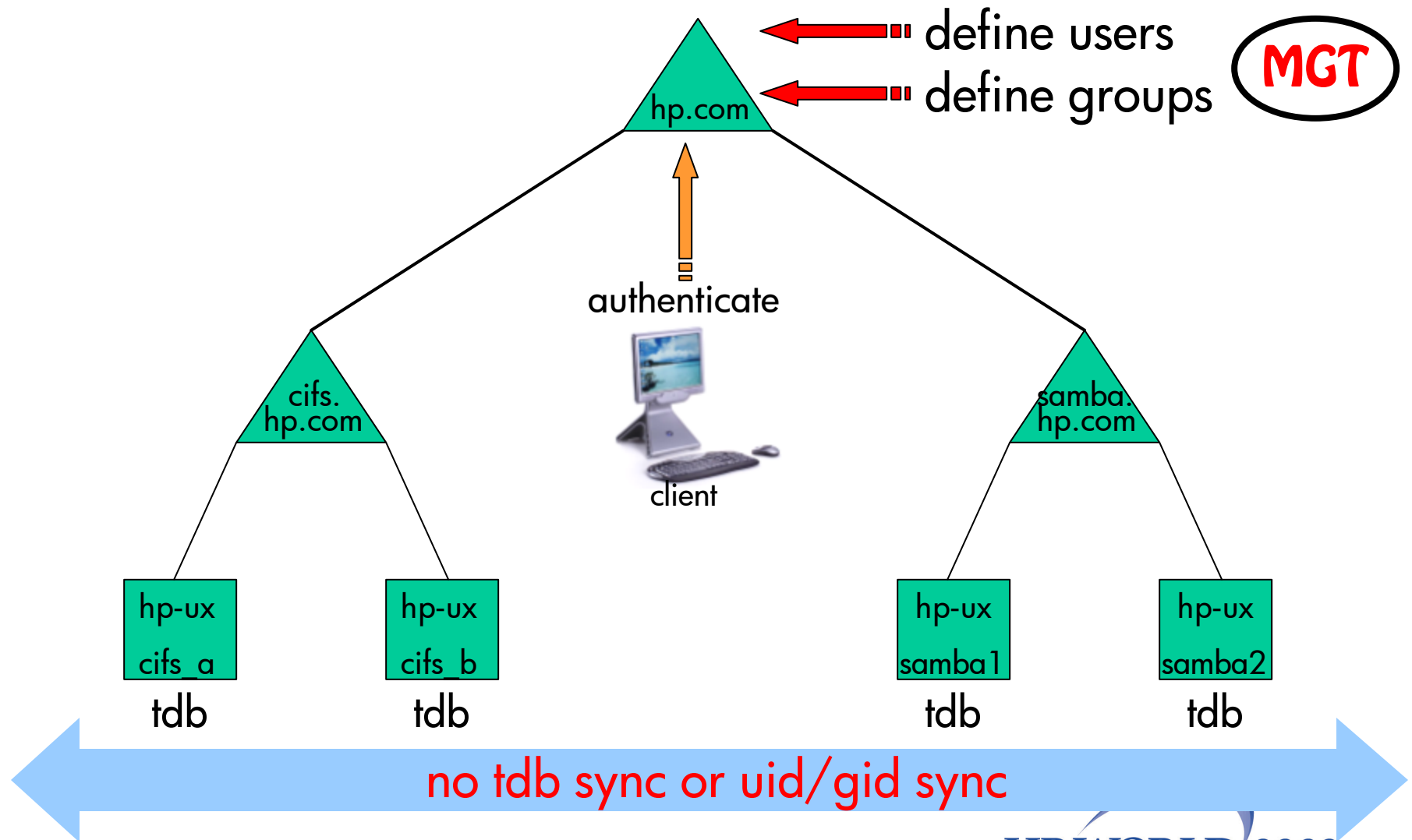

# 3: winbind management tool

## wbinfo

```
root > ./wbinfo
Usage: wbinfo -ug | -n name | -sSY sid | -UG uid/gid | -tm | -a user%password
  -u                lists all domain users
  -g                lists all domain groups
  -n name           converts name to sid
  -s sid            converts sid to name
  -N name           converts NetBIOS name to IP (WINS)
  -I IP             converts IP address to NetBIOS name (WINS)
  -U uid            converts uid to sid
  -G gid            converts gid to sid
  -S sid            converts sid to uid
  -Y sid            converts sid to gid
  -t                check shared secret
  -m                list trusted domains
  -r user           get user groups
  -a user%password authenticate user
  -p                'ping' winbindd to see if it is alive
  --sequence        show sequence numbers of all domains
emonster:/usr/local/samba/bin
```

```
root > ./wbinfo -u
SNSLATC+Administrator
SNSLATC+angel
SNSLATC+anya
SNSLATC+buffy
SNSLATC+cordelia
SNSLATC+darla
SNSLATC+eroseme
SNSLATC+giles
SNSLATC+Guest
SNSLATC+joecool
SNSLATC+krbtgt
SNSLATC+oz
SNSLATC+spike
SNSLATC+TslInternetUser
SNSLATC+willow
SNSLATC+xander
emonster:/usr/local/samba/bin
```

# 3: How it works

conceptual diagram  
not code-accurate

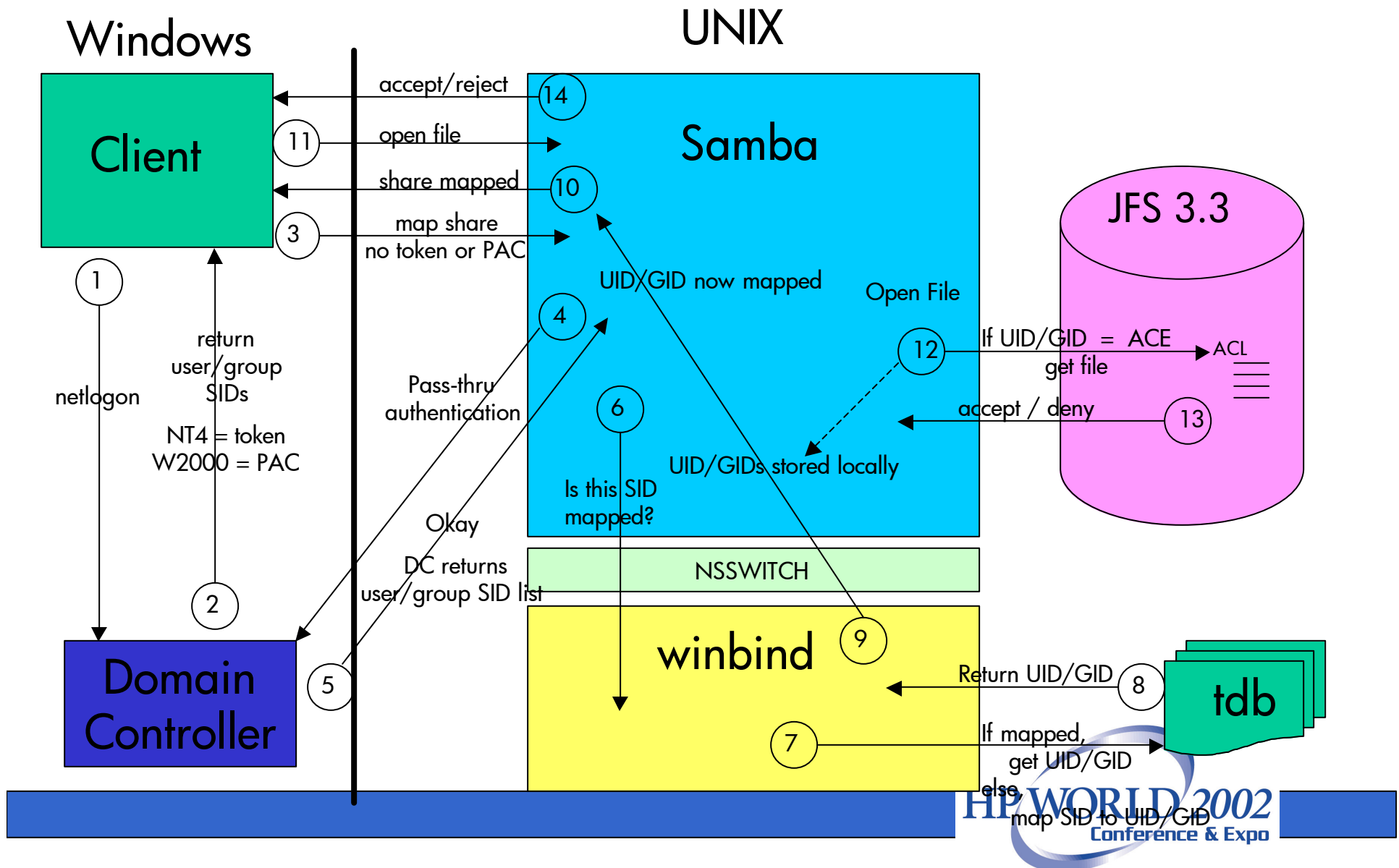



# Want to try winbind?

- Load pre-compiled samba 2.2.5 binaries
  - --with-winbind
  - [http://us1.samba.org/samba/ftp/Binary\\_Packages/hp/samba2.2.5/](http://us1.samba.org/samba/ftp/Binary_Packages/hp/samba2.2.5/)
  - Can exist on same CIFS/9000 Server system
- Whitepaper
  - Brief explanation
  - Installation and configuration instructions
  - Ask me for it
- Not supported by HP

# Management Summary

- UNIX Admins versus Windows Admins
  - Should not be an issue, but it is
- Unified Login is here today
  - See info sources
  - Very “clean” integration method
- winbind
  - Not supported with CIFS/9000 Server (yet)
  - Early in implementation cycle
  - Integration with LDAP and ADS would be nice

# Agenda – CIFS/9000

- CIFS/9000 Server review
- samba version tracking
- active directory integration
- authentication
- management

## ➤ file system

- name resolution
- DFS

# CIFS/9000 and HP-UX File System

- File Locking
- Oplock rules
- Virus checking
- JFS versus NTFS

# File Locking: CIFS and NFS

HP-UX 11 CIFS/9000 / NFS File Server & Storage

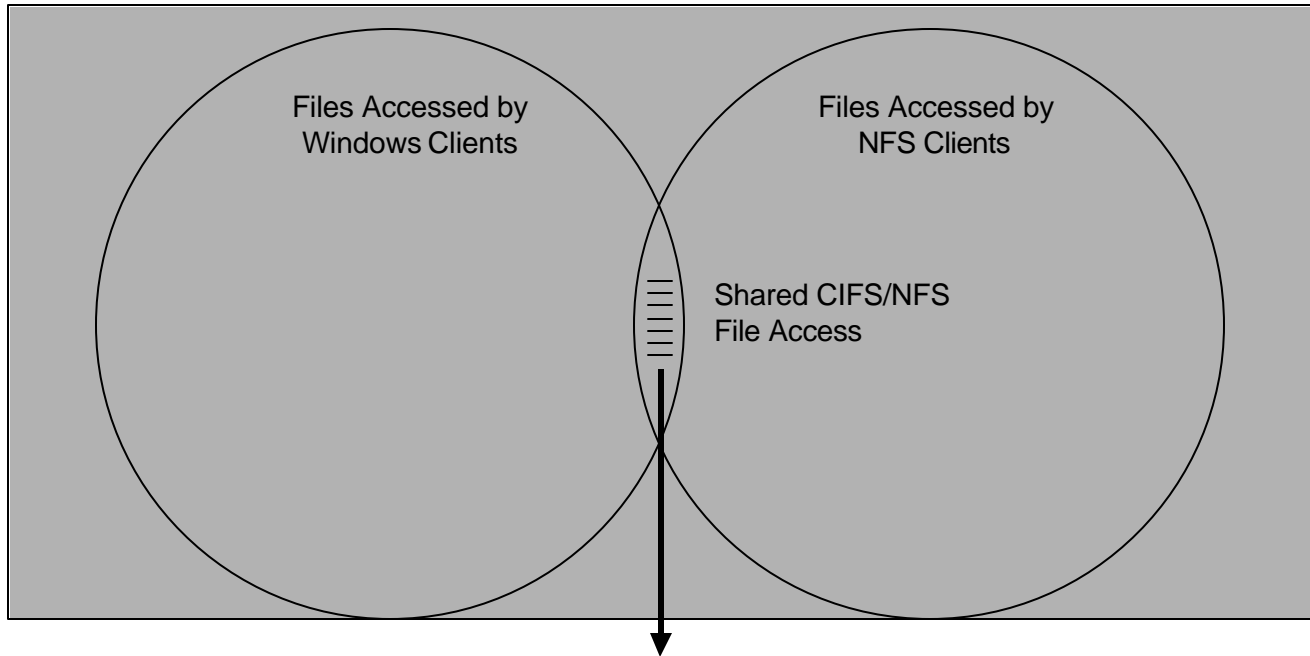

Filename	rwX	ACL	Data Mgt	Locking Needed?
Filename1	Read only	No ACL	No data management	NO
Filename2	Read/Write	ACE on ACL	No data management	NO
Filename3	Read/Write	No ACL	PDM, Clearcase, etc...	NO
Filename4	Read/Write	No ACL	No data management	YES – Locking Needed

# File Locking: CIFS and NFS

- **Byte Range** (record) locking
  - Windows-Windows
  - Windows-NFS (or UNIX)
    - NFS – Advisory locking protocol (fcntl)
- **Share Mode** locking
  - Windows-Windows
  - Windows-NFS (or UNIX)
    - NFS – Advisory locking protocol (fcntl)
- **Non-Locking NFS**
  - NFS/UNIX does not call fcntl
  - Requires VFS (Virtual File System) layer
  - CIFS enhancement: CIFS Extended Filesystem

# File Locking: CIFS and NFS

- **Byte Range** (record) locking

Windows - Windows  
- Windows - NFS (or UNIX)  
• NFS – Advisory locking protocol (fcntl)

**IN CIFS/9000 Server**

- **Share Mode** locking

Windows - Windows  
- Windows - NFS (or UNIX)  
• NFS – Advisory locking protocol (fcntl)

**IN CIFS/9000 Server**

- **Non-Locking NFS**

- NFS/UNIX does not call fcntl  
- Requires VFS (Virtual File System) layer  
- CIFS enhancement: CIFS Extended Filesystem

**Under Development**

# Oplock Definition

- Oplocks = Opportunistic Locking
- Oplocks: less about file locking
- Oplocks: more about client file caching
  
- A mechanism to allow clients to safely cache shared server files locally to the client, and perform reads, writes, and locks locally
- Reduces networked file operations
- Increases perceived performance



# Oplock Operation

- First client opens file – exclusive access
- First client is free to cache reads/writes
- Big performance boost over network reads/writes
- Second client sends file open request to server
  - Server sends oplock break to first client
- First client must flush all changes to server disk
- First and Second client get read access

# Oplock Rules

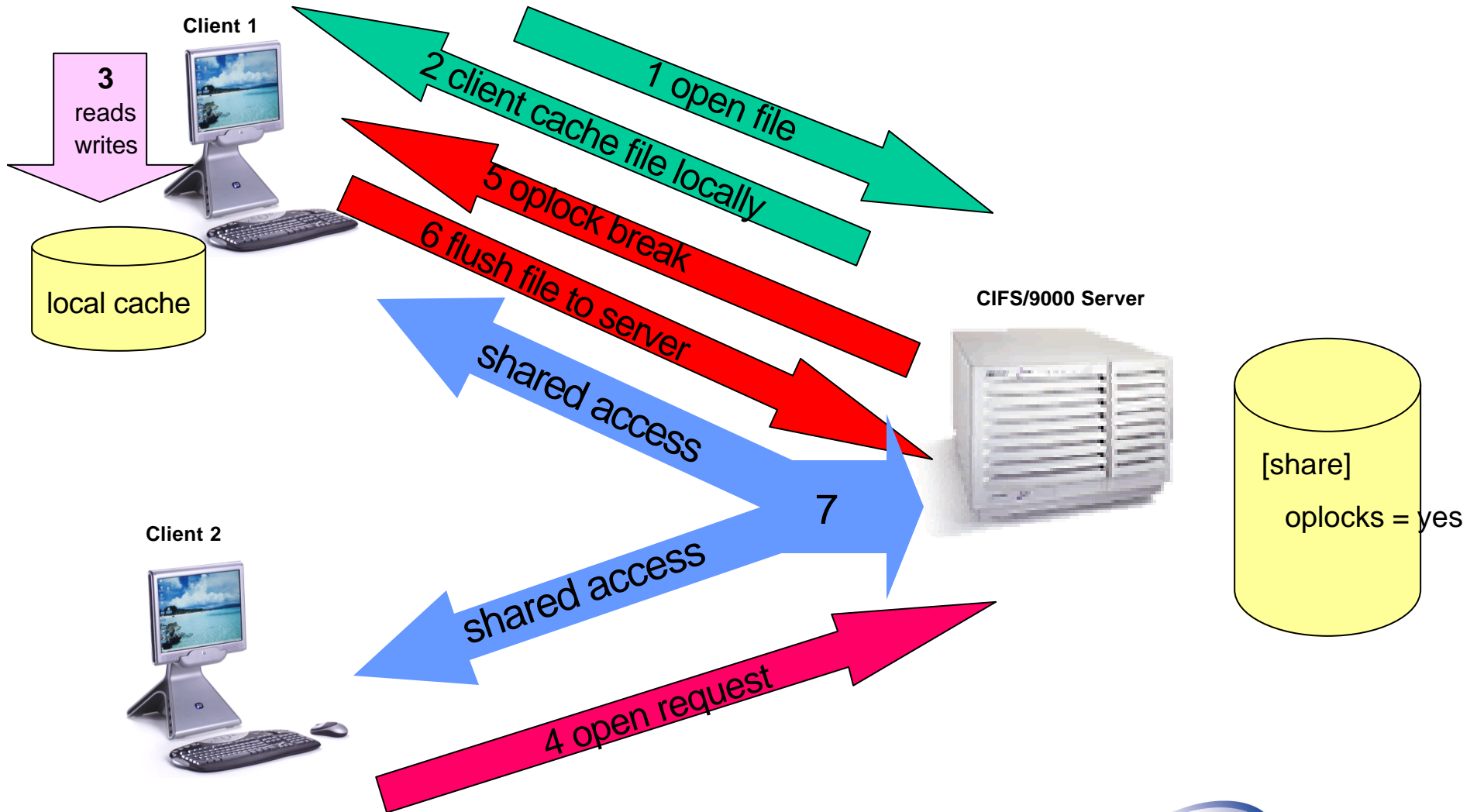

# Oplock Rules

1. Only enable on exclusive access data
  - i. Example: home directories
2. When more than one user accesses a file...
  - i. Managing oplocks can offset performance gain
3. On slow or unreliable networks and servers
  - i. Disable oplocks: latency causes timeouts – poor performance
4. Never set oplocks on multi-user database files
  - i. Example: Microsoft Access

# Oplock Rules

5. Never set oplocks on PDM data shares
  - i. Clearcase, Iman, Enovia
6. Force User
  - i. smb.conf parm causes oplock break
7. Advanced Samba Oplock parameters
  - i. If needed, just turn oplocks off!
  - ii. Example: “oplock break wait time” “oplock contention limit”
8. Mission Critical HA
  - i. Lose cache at failover

# Virus Checking

- Client Scan on share access
  - Traditional Windows anti-virus (Norton, etc...)
- Scan for Windows viruses on HP-UX
- Sophos Anti-Virus tested
  - [www.sophos.com](http://www.sophos.com)
- Sophos Scanning methods
  - Sweep: scheduled scan of files, directories, shares
  - InterCheck: scans on access
- Also: dedicate anti-virus client, full-time scan

# FileSystem: JFS vs NTFS 5.0

Feature	File System			
	NTFS 5.0	NTFS 4.0	JFS 3.3	JFS 3.5
EFS	yes	no	no	no
UDF	yes	no	no	no
DFS Replication	yes	no	no	no
Reparse Points	yes	no	no	no
Sparse Files	yes	no	no	no
Directory Junctions	yes	no	no	no
Volume Mount Points	yes	no	no	no
Link Tracing	yes	no	no	no
File Compression	yes	no	no	no
Change Journal	yes	no		
Disk Quotas	yes	no	yes	yes
User	yes	no	yes	yes
Volume	yes	no	no	??
Indexing Service				
EFS	Encrypted File System			
UDF	Universal Disk Format			
DFS	Distributed File System (Microsoft feature)			

# File System Summary

- File Locking
  - Assess true CIFS-NFS locking requirement
  - CIFS/9000 covers most CIFS-NFS requirement
  - Full NFS-nonlocking protection in development
- Oplocks
  - Really is client local file caching
  - Configure as a toggle
    - Exclusive access: on
    - Multi-access: off
- Anti-Virus: Sophos
- NTFS vs JFS
  - Only Windows does full NTFS feature set

# Agenda – CIFS/9000

- CIFS/9000 Server review
- samba version tracking
- active directory integration
- authentication
- management
- file system

## ➤ name resolution

- DFS



Review

# Name-Address Resolution

- NetBIOS/WINS: NT4 and CIFS/9000
- BIND – UNIX DNS
- Windows 2000 DNS

## ➤ Purpose

1. Resolve and Update Names
2. Schema for Data Storage
3. Replicate the Data

Review

# NetBIOS: NT4 and CIFS/9000

- NetBIOS
  - NT4 (and prior) Name Resolution Protocol
  - RFCs 1001 (protocol) and 1002 (structures)
- **CIFS/9000 REQUIRES NetBIOS**
- CIFS/9000 NetBIOS Name = HP-UX Hostname
  - NetBIOS name length =< 15 Characters
    - 16<sup>th</sup> char is the name suffix
  - ***HP-UX uname =< 8 Characters***
- Single CIFS/9000 nmbd daemon listens for NetBIOS
- W2000 Default is: NetBIOS Enabled



Review

# NetBIOS - WINS

- WINS – (Windows Internet Name Service)
  - NetBIOS uses WINS
  - NT4 Domain Name Service – multi subnet
  - H-Node NetBIOS: try WINS first, then Broadcast name
- CIFS/9000 WINS
  - Best to use W2000 WINS server (enhanced NT4)
  - W2000 Clients more WINS flexible
- Configure Primary WINS server in smb.conf
  - Secondary WINS Server enhancement coming

# Review Windows 2000 DNS

- “DDNS” – Dynamic DNS (tied to DHCP)
- Replaces NT4 NetBIOS-WINS
- Default Name Resolution – DDNS
- Microsoft Recommends WINS Compatibility
  - Default: WINS Enabled
  - Many applications need WINS, even in pure W2000 domain
- Pure W2000 Domains can Disable WINS-NetBIOS
  - Even Microsoft recommends WINS-NetBIOS Enabled
- **By default CIFS/9000 Uses NetBIOS**



# WINS vs DNS: What is the Issue?

- Objective: remove NetBIOS. Use DDNS.
- Reduce Network traffic
  - NetBIOS UDP broadcasts
  - Name resolution only
- Eliminate WINS server administration
  - Only when running DDNS and WINS
- Others?

# CIFS/9000 and DNS

- Samba Defaults to ports 137, 138, 139
  - 137: UDP, listens for NetBIOS name resolution
  - 138: UDP, listens for datagrams
  - 139: TCP, NetBT session connections
- Samba can be configured to listen on port 445
- Port 445 is the TCP port that W2000 listens on
- `smbd -D -p 445`
  
- Do Not use port 445 for anything else, ever

# CIFS/9000 and DNS

- Can CIFS/9000 Server use DNS?
  - Yes and No
- Stand-Alone CIFS/9000 Server
  - **Yes**: Can probably use DNS for
    - Share mode security
    - User mode security
    - Server mode security
  - In a simple network configuration

# CIFS/9000 and DNS

- Can CIFS/9000 Server use DNS
  - Yes, no, maybe
- CIFS/9000 Member server – W2000 Domain
  - Yes: can receive client connect on 445
  - No: need DNS SRV record support for full interop
    - Must be able to locate domain server services
    - Equivalent of NetBIOS name suffixes: 1c, 1b, etc...
  - Maybe: you may be able to make it work
    - Simple config
    - Unsupported by HP



# CIFS/9000 DNS Key Issue

- Can do either DNS (445) or NetBIOS (137)
- W2000 actually uses fall-back protocol
  - Tries DNS (445)
  - If DNS fails, uses NetBIOS (137-139)
- That's why Microsoft recommends NetBIOS
  - **Enabled**
  - Fallback name resolution mechanism
- CIFS/9000 DNS has no fallback built in
  - Can configure 445 on inetd, 137-139 by default

# Why Use DNS?

- NetBIOS uses UDP broadcasts
- Can affect network traffic congestion
  - This is probably overstated
- Eliminate WINS management
  - Managing both DNS and WINS is redundant
  - What are the real savings?
- NetBIOS Broadcast operations
  - Client-DC name resolution
  - Client-Fileserver name resolution
  - Fileserver-DC name resolution
  - Browsing

# CIFS/9000 DNS Recommendation

- Not HP supported
- Not HP tested
- Theoretical advantages (until fully coded)
  
- Assess true network traffic level
- Compare WINS management savings
  - With increased DNS complexity
  
- ***Leave NetBIOS enabled***
  - *In W2000 domain, Native or Mixed*
  - *Per HP's and Microsoft's recommendation*

# Agenda – CIFS/9000

- CIFS/9000 Server review
- samba version tracking
- active directory integration
- authentication
- management
- file system
- name resolution

## ➤ DFS

# What is W2000 DFS?

- DFS: Multiple Servers → Common Namespace
- NOT!: OSF DCE/DFS (TransARC)
- Referrals
  - Transparent share mapping
  - Map “Root” share – source of common namespace
  - Root subordinate server mappings are “referred”
    - Referral is simply a re-directed share map to another server, but appears as a local directory
- W2000 DFS Features

# DFS Enhancements

- Today: DFS Leaf Node
  - CIFS/9000 server as a referral directory
  - See “CIFS/9000 and Windows 2000 Interoperability”
    - <http://www.interex.org/conference/iworks2001/proceedings/home.html>
- Today – ***NEW: DFS Root Node***
  - CIFS/9000 server hosts root share
  - Refers virtual subdirectories to Leaf Nodes

# DFS Review

## Standard Namespace

- 3 Mapped Shares
- 3 Servers
- 3 Logical Drives
- 3 “Namespaces”

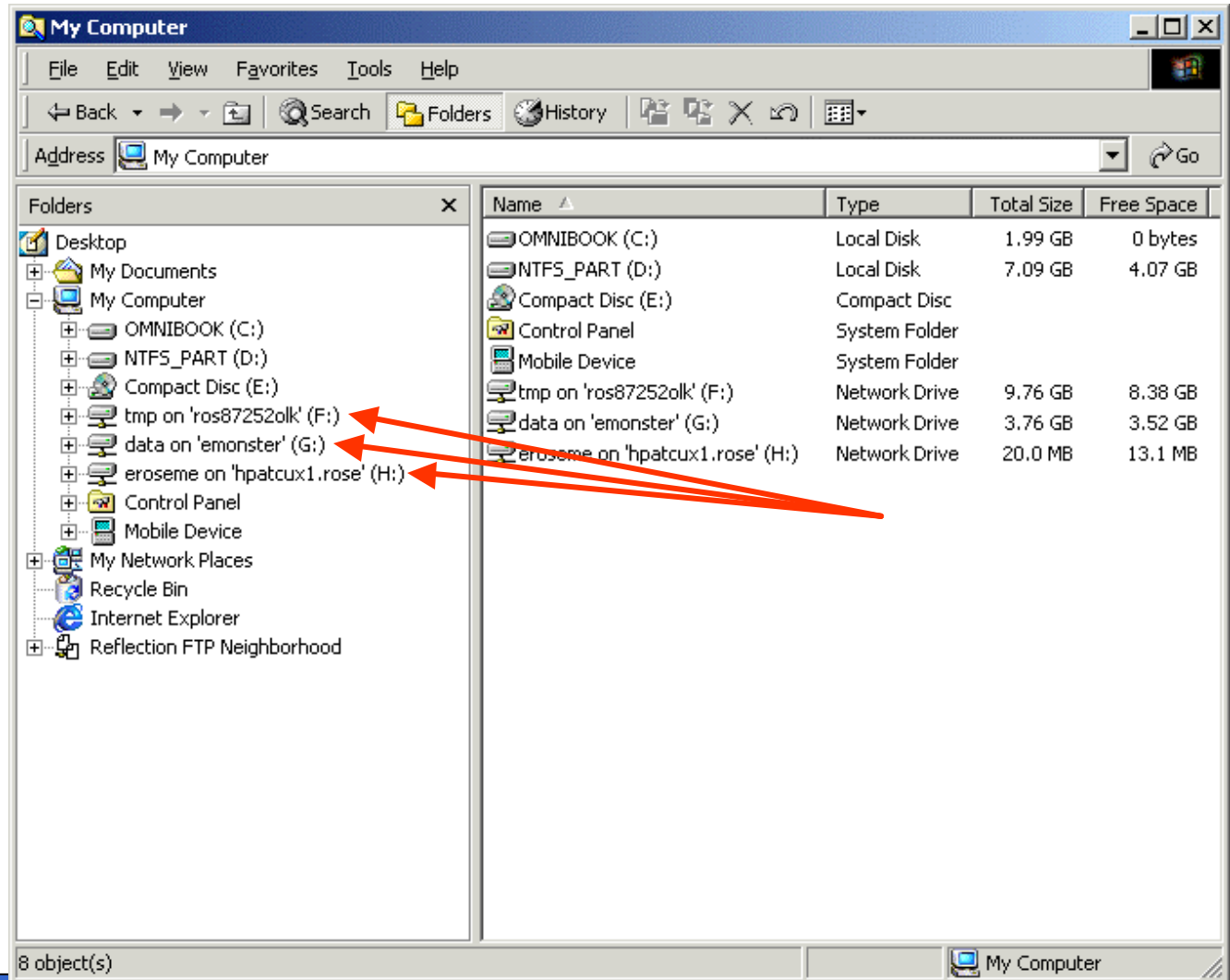

# DFS Review

# Single W2000 DFS Namespace

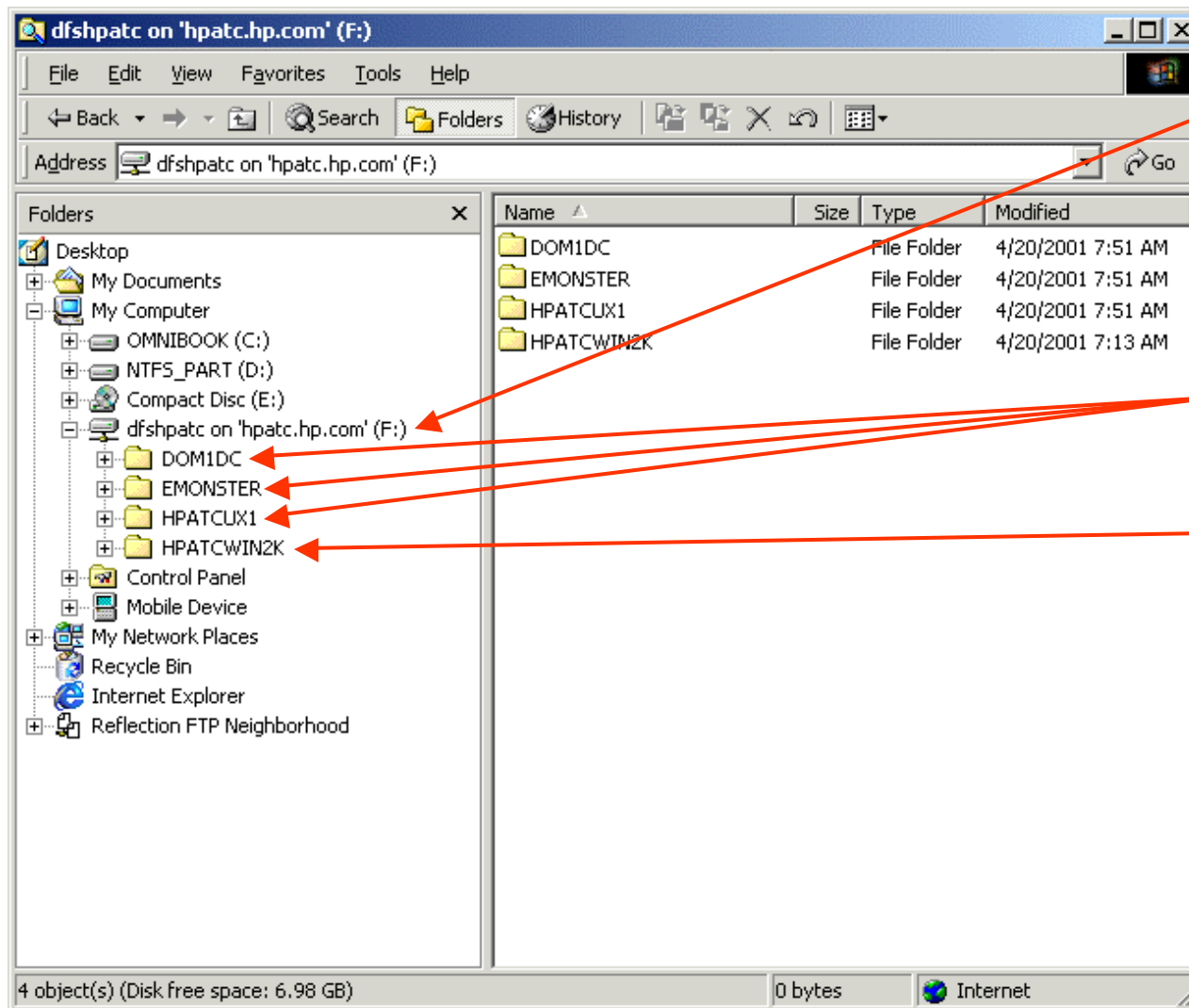

- W2000 Root Share
- Single Namespace
  - dfshpatc
- 3 Remote Servers
  - 2 CIFS, 1 W2000
- 1 Local Filesystem
  - Local to the root
- Namespace exported to any client



# Single CIFS/9000 DFS Namespace

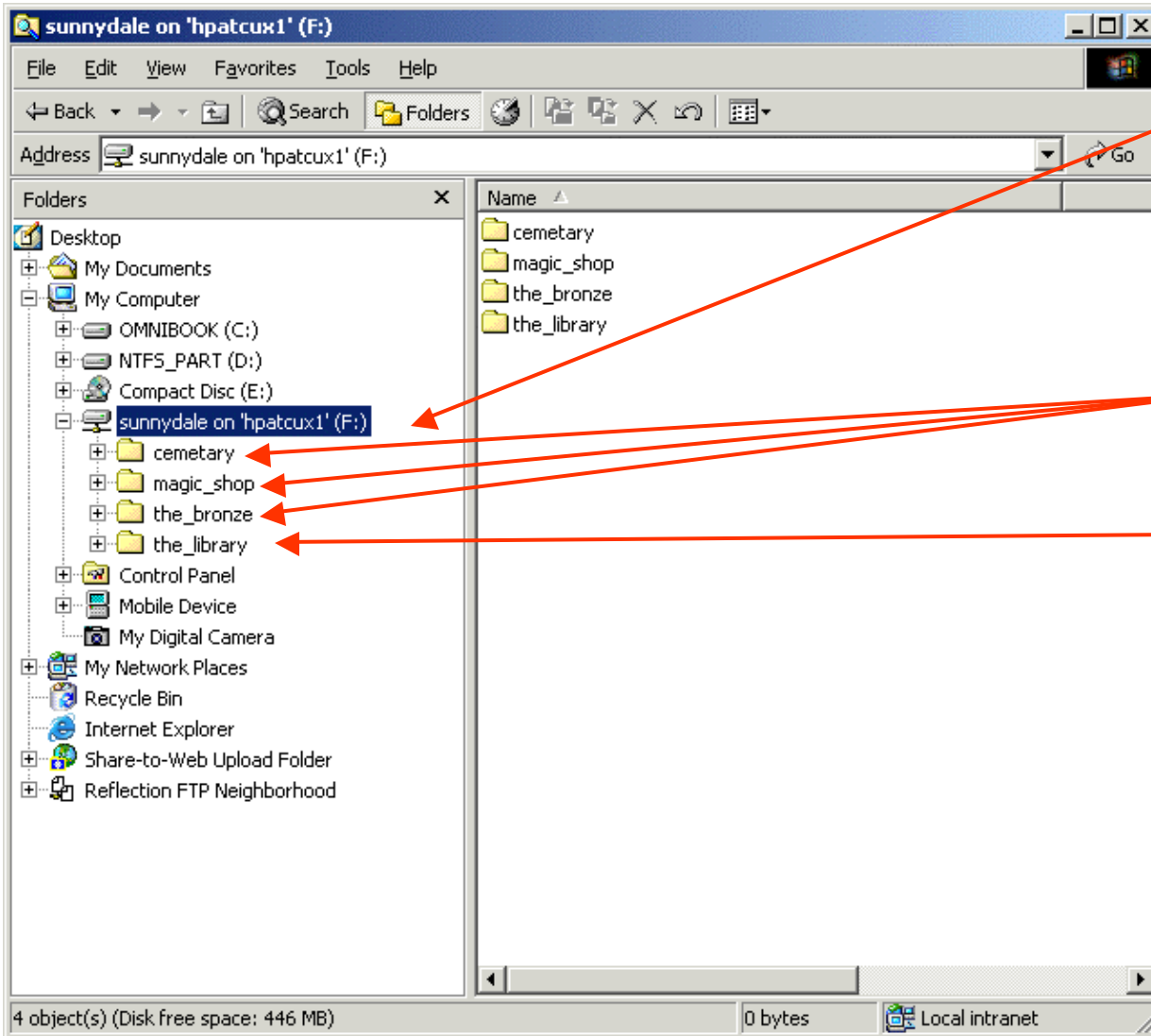

- CIFS/9000 root share
- Single Namespace
  - sunnydale
- 3 W2000 Servers
- 1 Local Filesystem
  - Local to the root
- Namespace exported to any client

# CIFS/9000 DFS Details

- DFSRoot in version A.01.08
- DFSLink (leaf node) in all versions
- CIFS/9000 DFS root host
  - W2000 DFSLink
  - CIFS/9000 DFSLink
- DFSRoot can configure fault tolerant links
- Admin is with SWAT and HP-UX command line

# DFS Recommendation

- For W2000 domains, use W2000 root
  - If possible
  - Centralized admin
- For W2000 domains with limited DC access
  - Use CIFS/9000 Server root
- DFS deferrals have minimal impact on server
- Can configure fault tolerance
- Can configure replication with rsync

# Agenda – CIFS/9000

- CIFS/9000 Server review
- samba version tracking
- active directory integration
- authentication
- management
- file system
- name resolution
- DFS

## ➤ Summary

# Summary



- Samba Version Tracking
  - CIFS/9000 reliability is top priority
  - Test the latest CIFS/9000 Server and Samba versions in your own environment
- Active Directory Integration
  - CIFS/9000 Server data “published” in Active Directory with Samba 3.0
  - Other related benefits to be determined

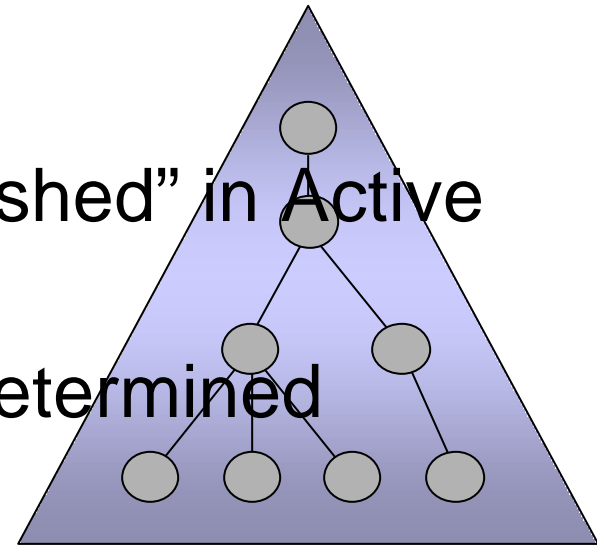

# Summary

- Authentication

- Full Kerberos in 2003
- Client, domain controller, CIFS/9000 Server



- Management

- Default Samba requires user-group sync with Windows
- Unified Login stores POSIX user-group data in ADS: excellent solution
- Winbind
  - maps user-groups – good in certain configurations
  - Not HP supported (yet)
  - You can try it!

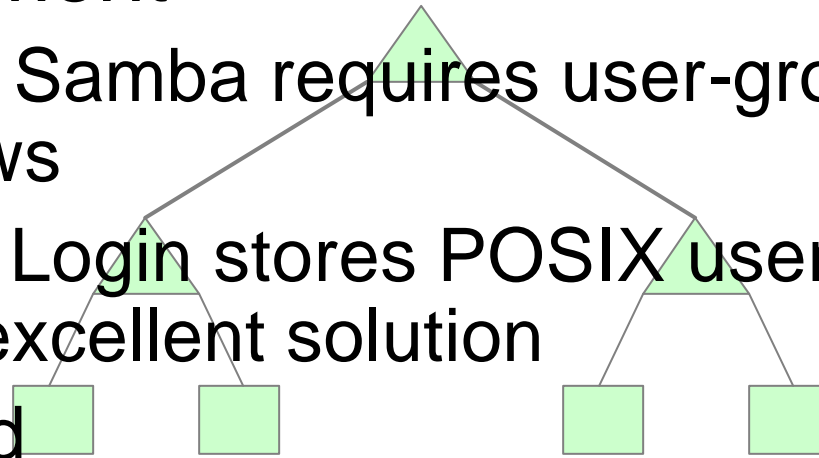

# Summary

- File System

- Locking

- assess legitimate locking requirements
    - Full CIFS-NFS locking in development

- Oplocks

- Really just local file caching
    - Complex and prone to defects
    - Use sparingly in specific cases: single user access

- Anti-Virus

- Sophos for sweeping Windows viruses on HP-UX

- NTFS vs POSIX

- Only Windows does full NTFS feature set

# Summary

- Name Resolution
  - Windows 2000 offers Dynamic DNS (DDNS)
  - CIFS/9000 Server requires NetBIOS
  - CIFS/9000 Server can run on TCP port 445
  - Can turn off NetBIOS if you really know what you are doing with DNS (not in W2000 domain)
  - Not currently HP supported
- DFS
  - CIFS/9000 Server: Leaf AND Root node
  - Windows 2000 ADS DFS more feature-rich



# Feedback

- Top 3 Windows integration features?
- Top 3 non-Windows integration features?
- CIFS/9000 Server versus Samba?